

ROOM FINISH SCHEDULE

ROOM	FLOOR	WALLS	CEILING
TOILETS	HYDROSEAL	PAINTED BRWD	STAINED & VARNISHED
SHOWERS	CERAMIC	CERAMIC	DO.
PIPE SP.	COCC.	UN. FINISHED	UN. FINISHED

No.	DATE	BY	REVISION
1	2-8-70	J.P.	AS SHOWN
2	2-8-70	J.P.	REVISED
3	2-8-70	J.P.	REVISED
4	2-8-70	J.P.	REVISED
5	2-8-70	J.P.	REVISED
6	2-8-70	J.P.	REVISED
7	2-8-70	J.P.	REVISED

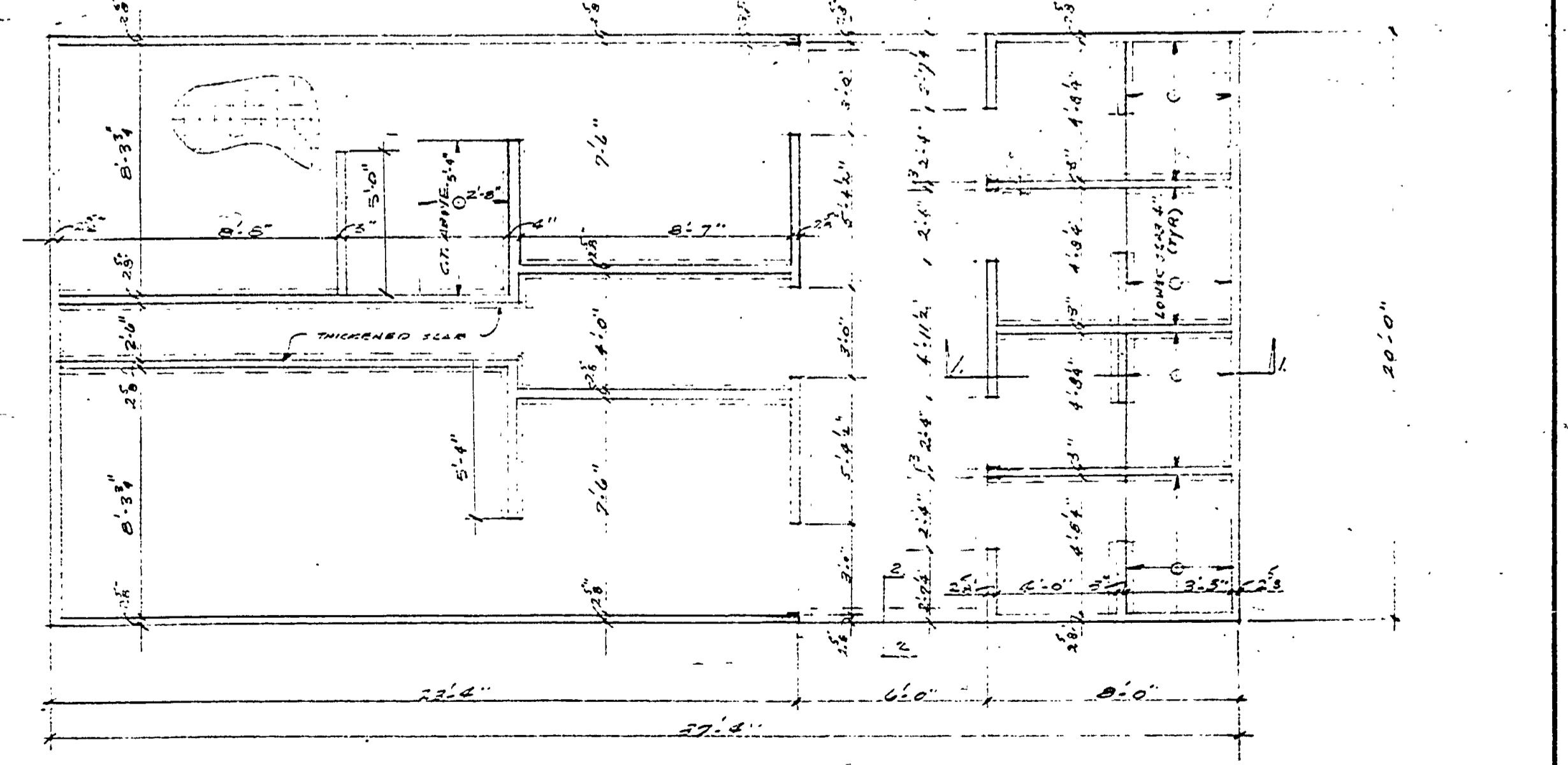
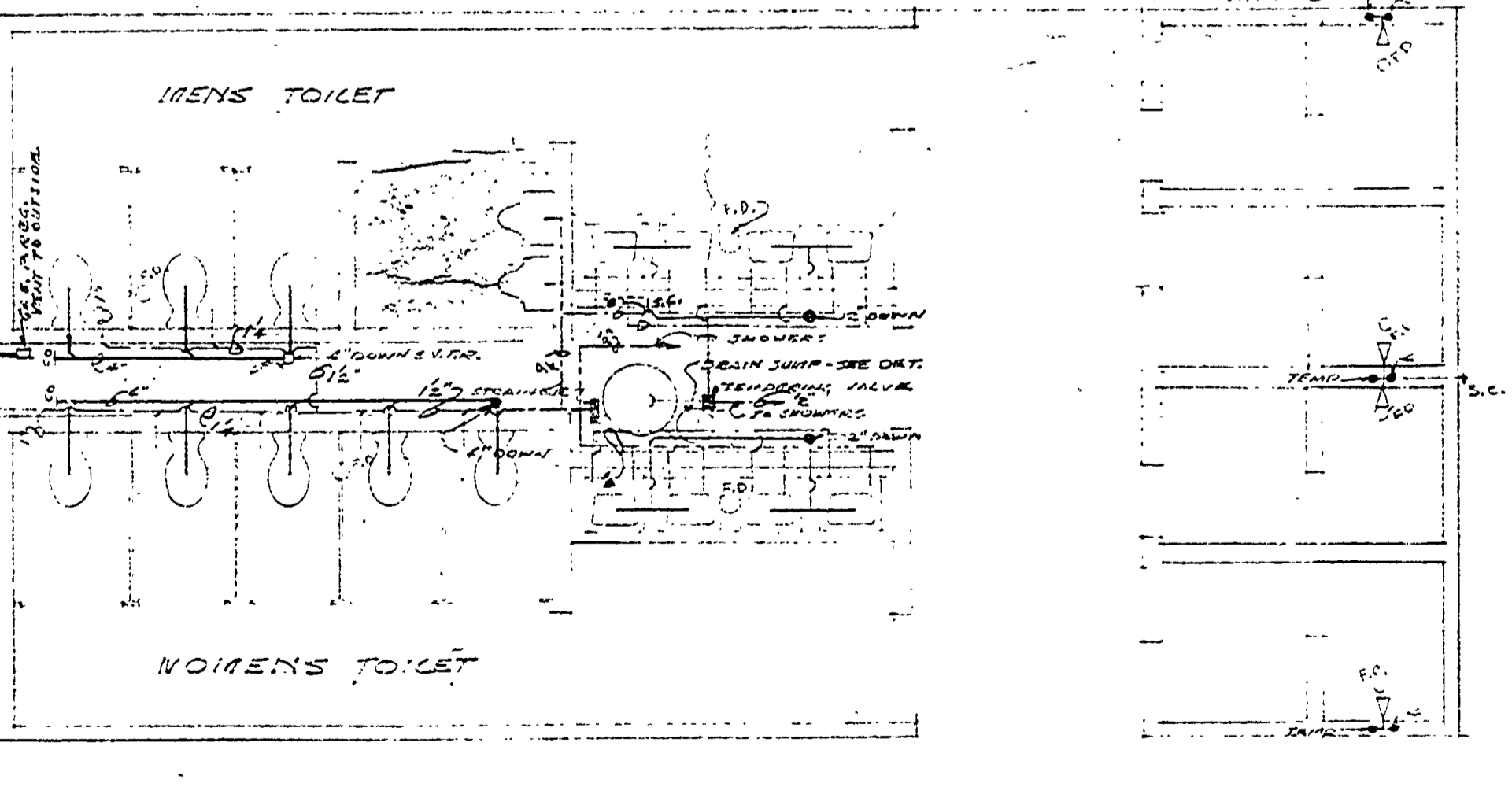
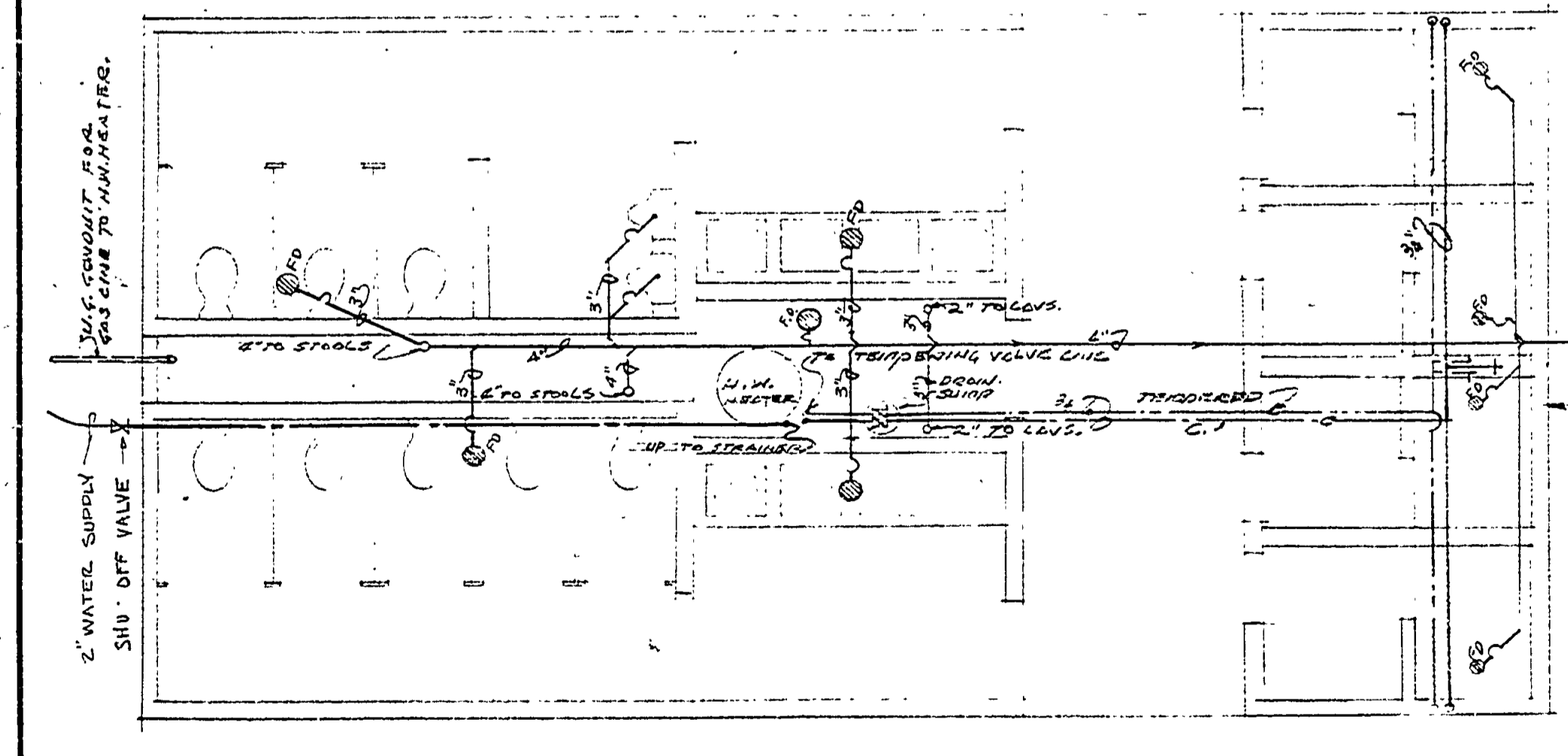
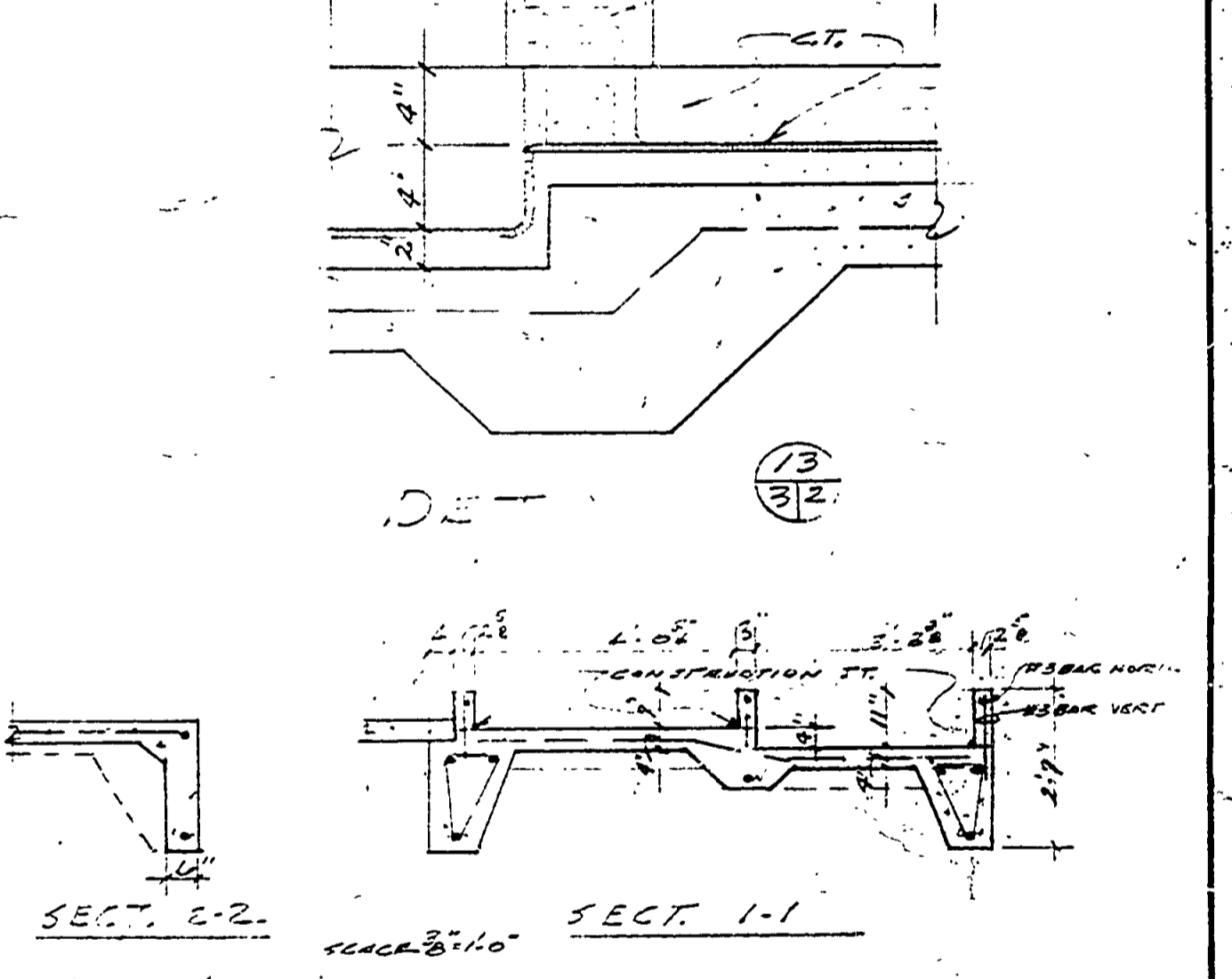
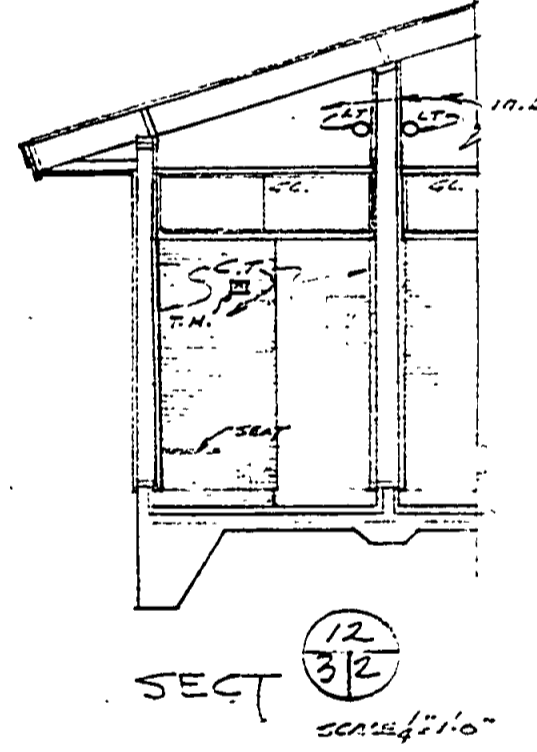
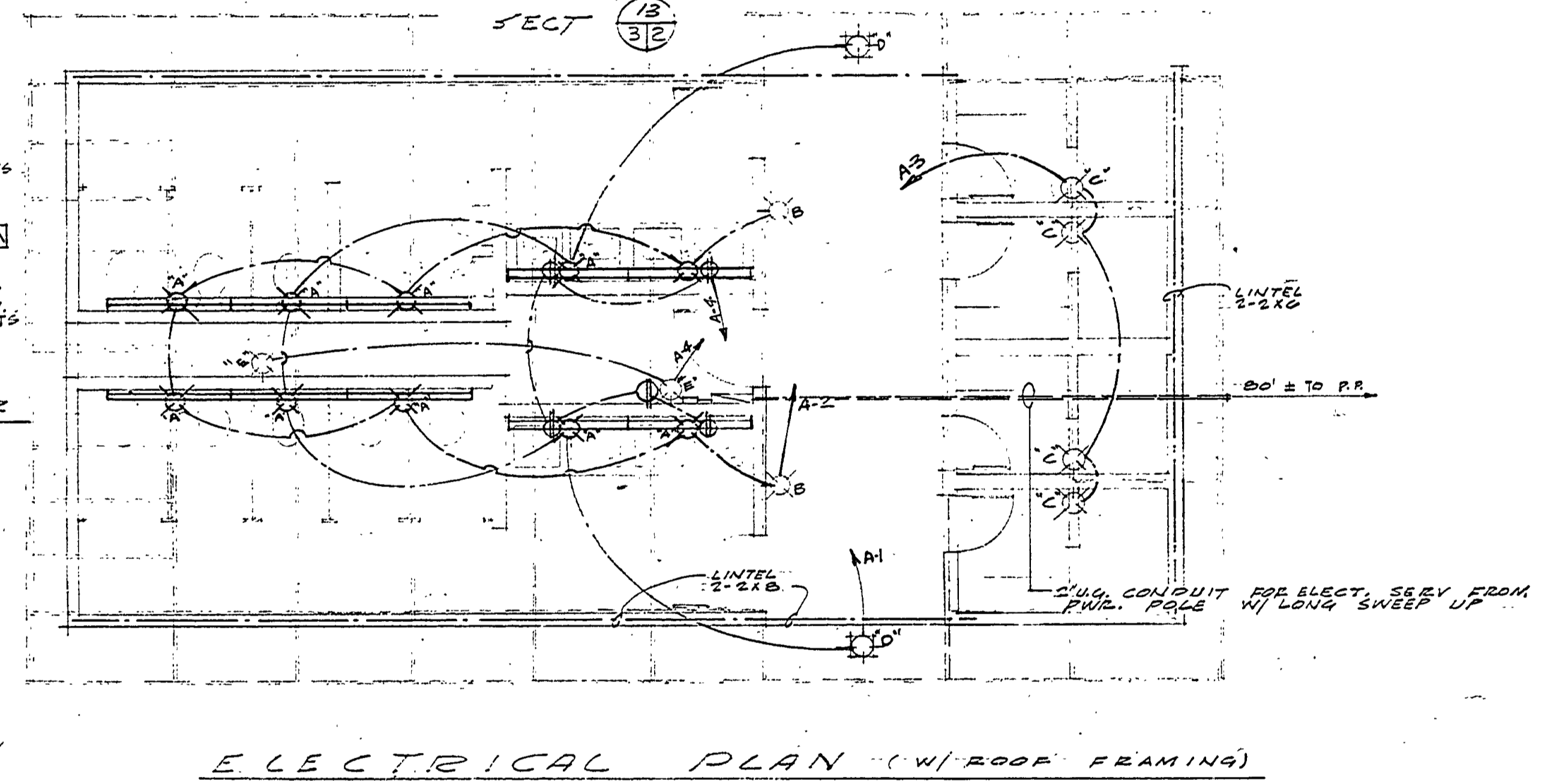
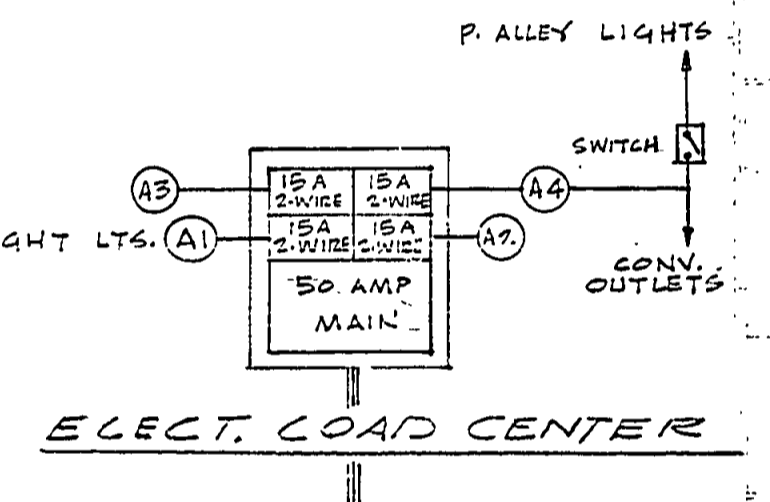
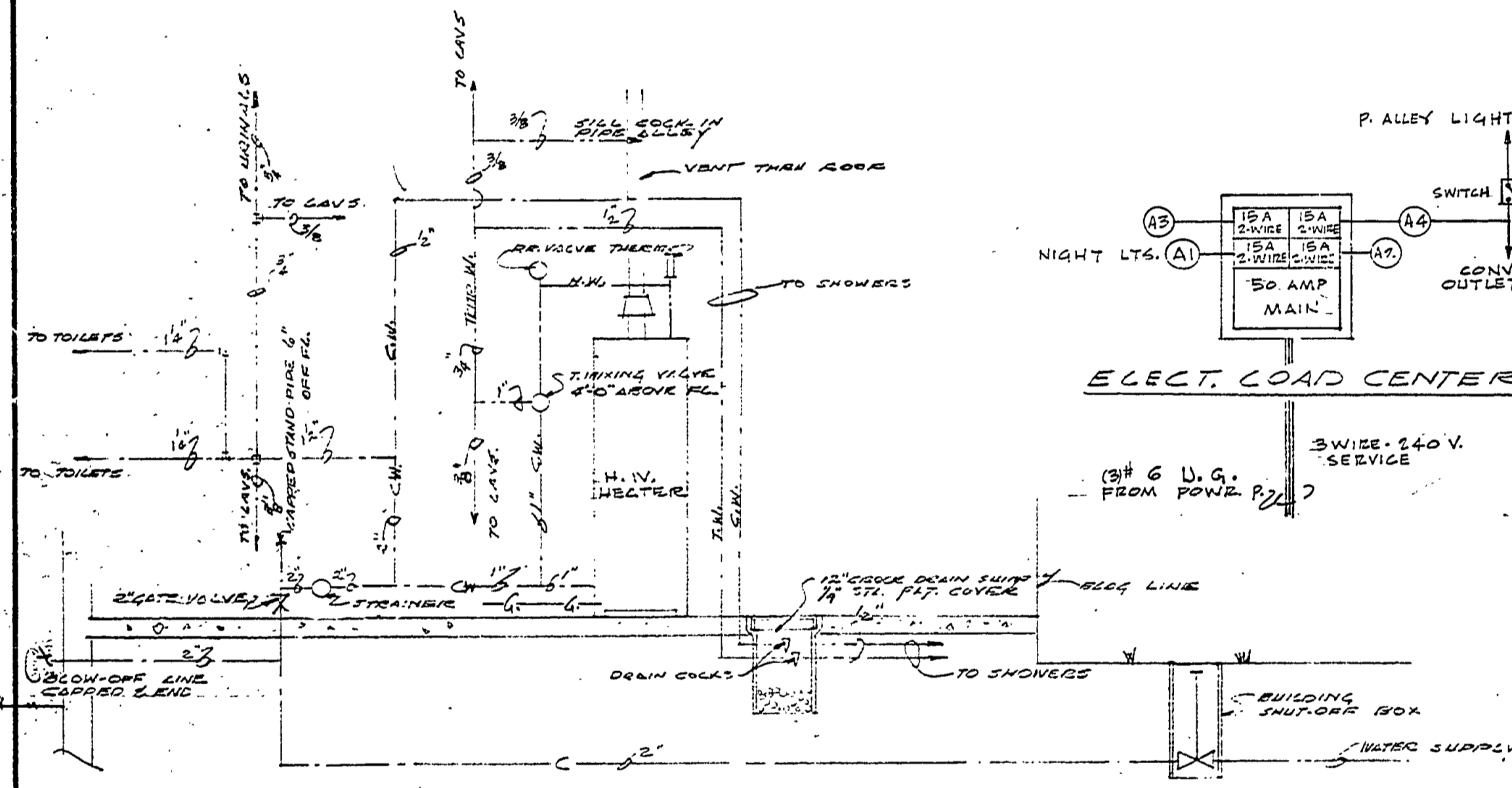

SURVEYED BY	DESIGNED BY	DATE	NO.	DATE	BY	REVISIONS
			1.	2-7-70	WSP	CHANGE DEC 4/5/67 FROM 2-10-68
			2.			

MICHIGAN DEPARTMENT OF CONSERVATION

MUSKALLONGE LAKE STATE PARK  
TOILET & SHOWER BLDG. A

SHEET NO. 2 OF 3  
FOR PROJECT NO. 165-5124-30-012

FOR. ELECT & PLUMB. PLANS  
SHEET 2 OF 3  
PLAN NO. A-100