

DOORS
2'-4" x 6'-0" x 1 1/2"
2 SETS REQUIRED
SCALE 1/2" = 1 FT.

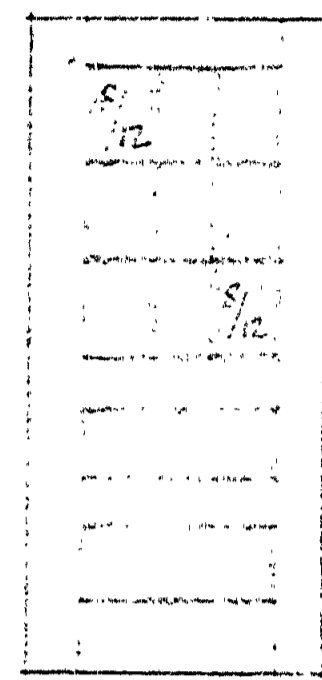

DOORS
2'-0" x 6'-0" x 1 1/2"
1 SET REQUIRED
SCALE 1/2" = 1 FT.

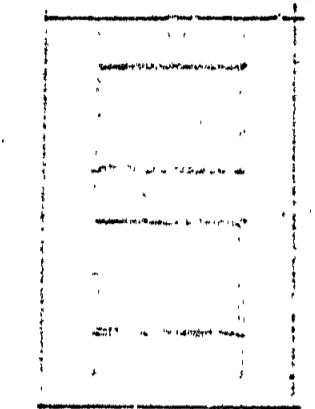

BOOTH DOORS
2'-6" x 4'-0" x 1 1/2"
13 REQUIRED
SCALE 1/2" = 1 FT.

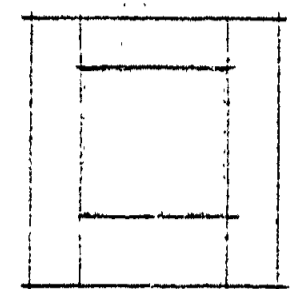

CHECK ROOM DOOR
2'-6" x 2'-0" x 1 1/2"
1 REQUIRED
SCALE 1/2" = 1 FT.

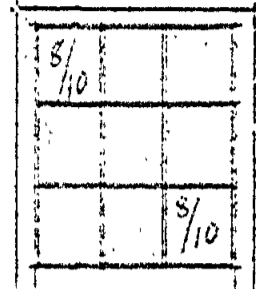

TYPICAL WINDOW
2'-0" x 2'-0" x 1 1/2"
36 REQUIRED
SCALE 1/2" = 1 FT.

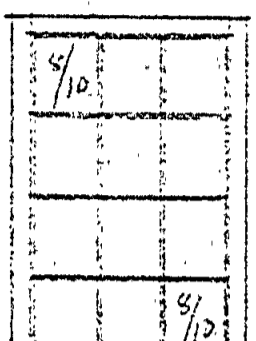

PORCH WINDOW
2'-0" x 1'-0" x 1 1/2"
6 REQUIRED
SCALE 1/2" = 1 FT.

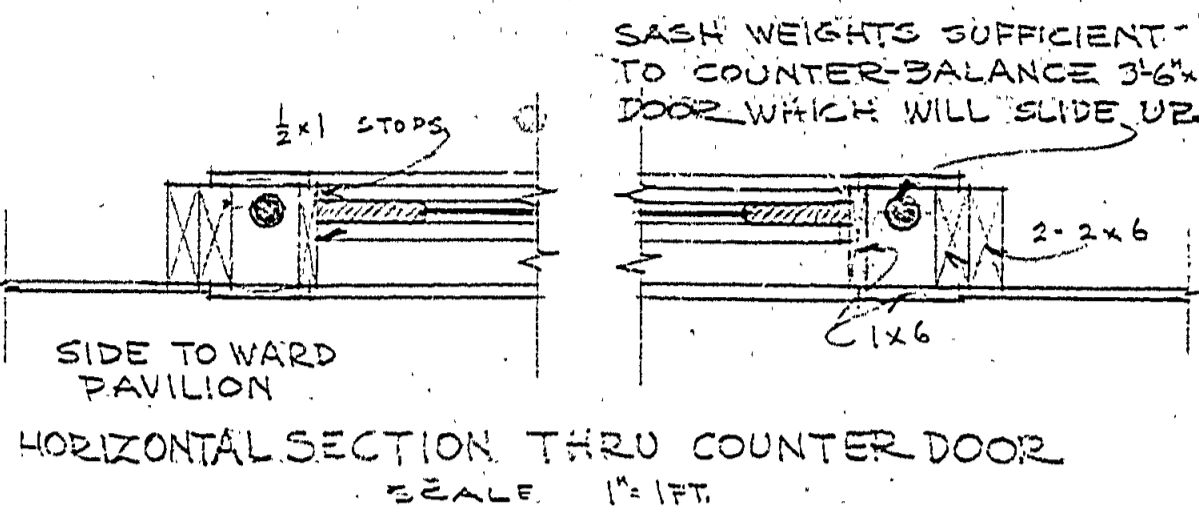

HORIZONTAL SECTION THRU COUNTER DOOR
SCALE 1" = 1 FT.

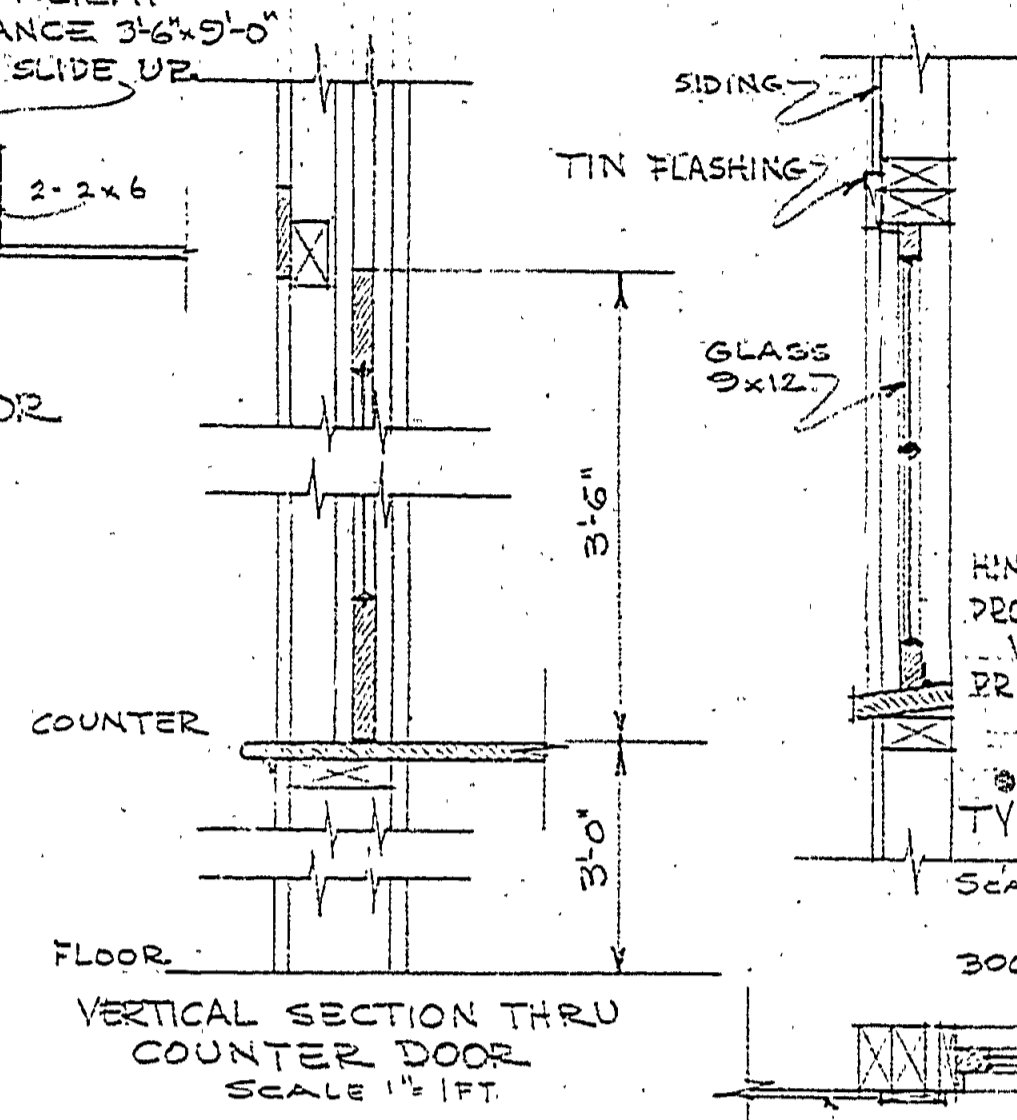

VERTICAL SECTION THRU COUNTER DOOR
SCALE 1" = 1 FT.

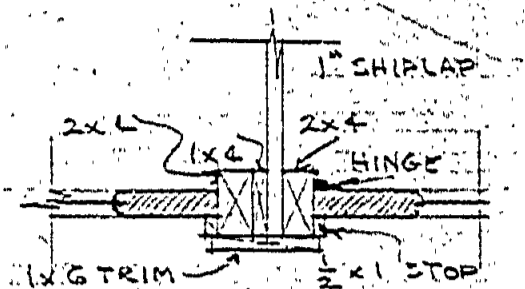

TYPICAL WINDOW HEAD & SILL DETAIL
SCALE 1" = 1 FT.

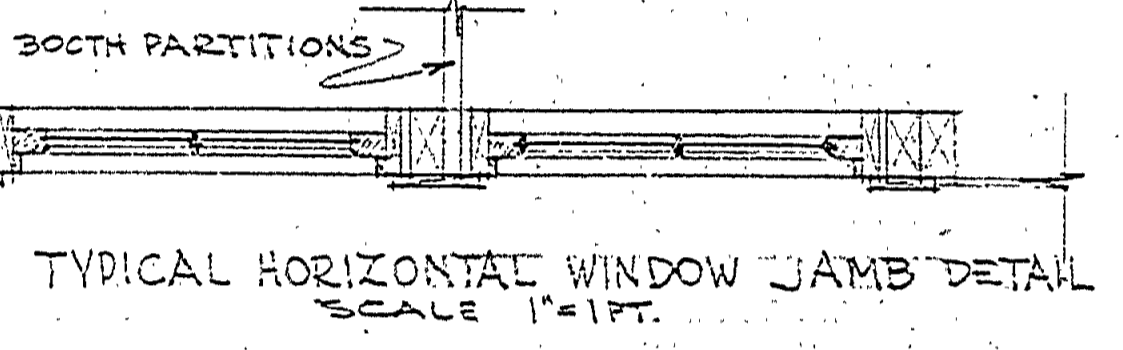

TYPICAL HORIZONTAL WINDOW JAMB DETAIL
SCALE 1" = 1 FT.

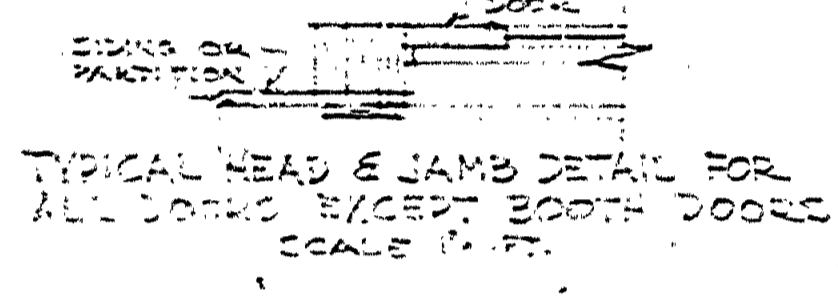

TYPICAL HEAD & JAMB DETAIL FOR ALL DOORS EXCEPT BOOTH DOORS
SCALE 1" = 1 FT.

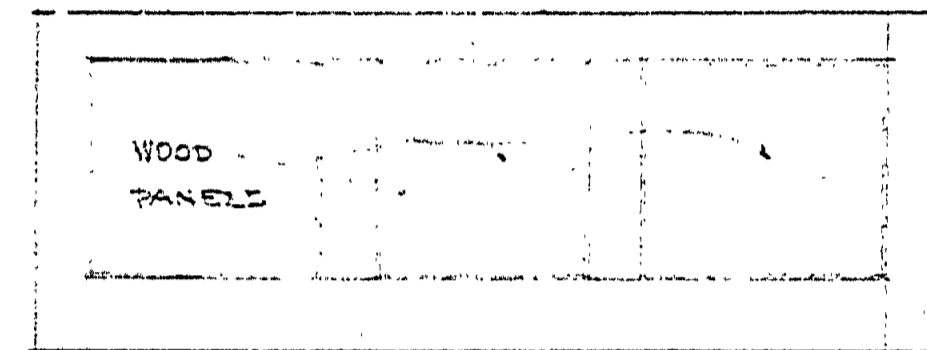

COUNTER DOOR
3'-6" x 5'-0" x 1 1/2"
1 REQUIRED
SCALE 1/2" = 1 FT.

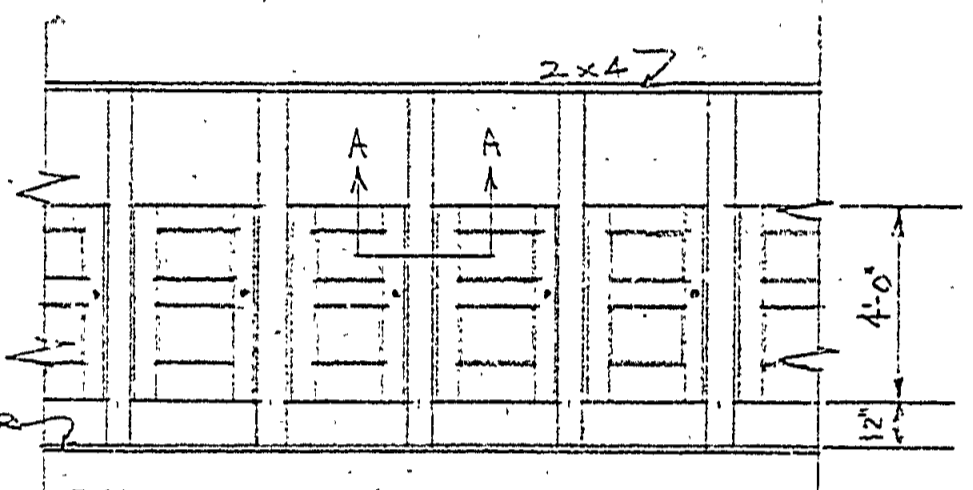

TYPICAL ELEVATION BOOTHS
SCALE 1/2" = 1 FT.

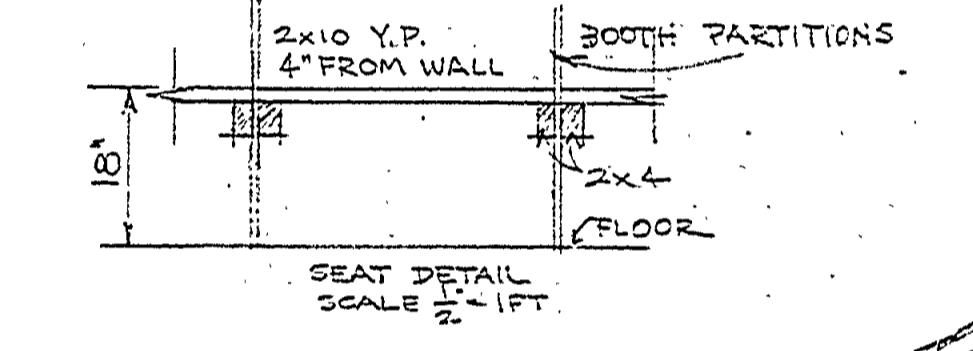

SEAT DETAIL
SCALE 1/2" = 1 FT.

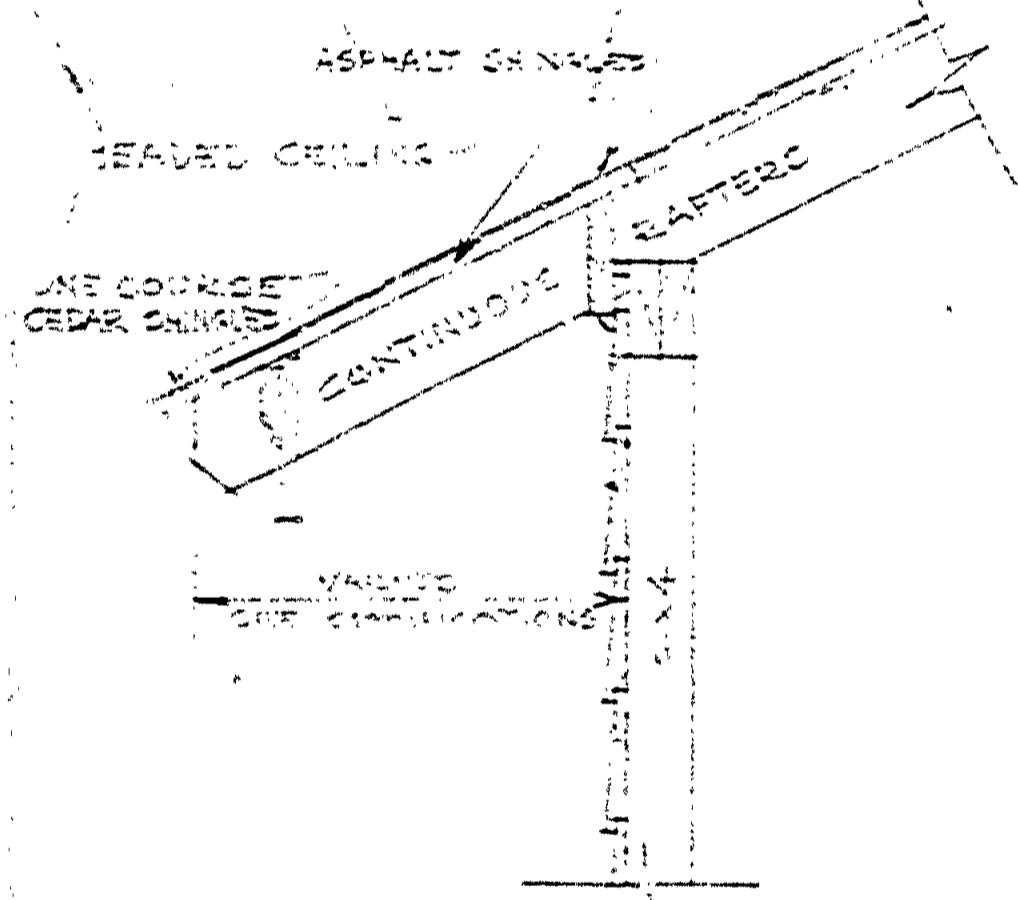

TYPICAL DETAIL AT EAVES
SCALE 1" = 1 FT.

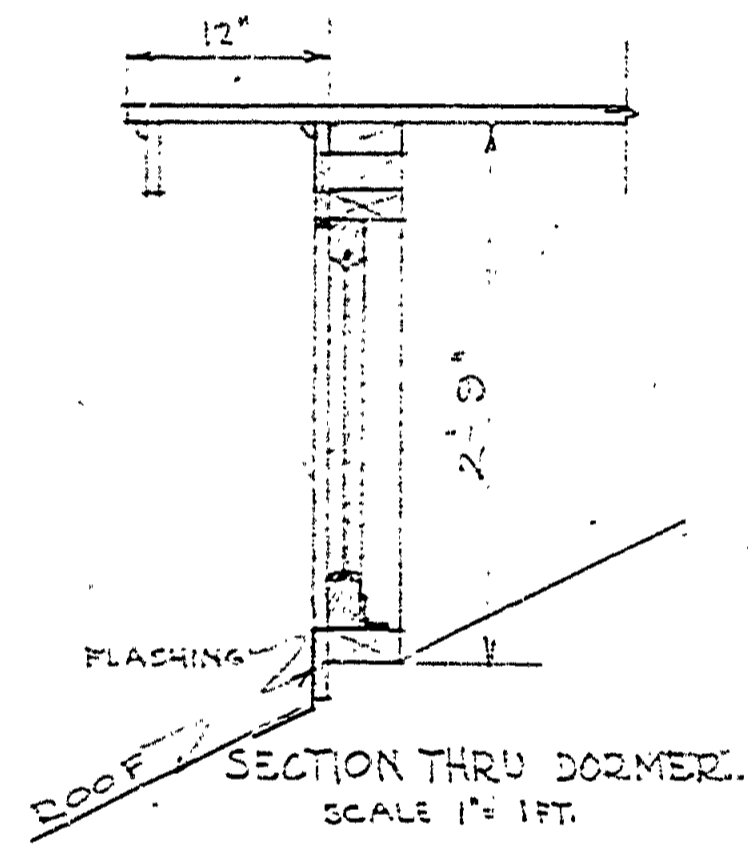

SECTION THRU DORMER
SCALE 1" = 1 FT.

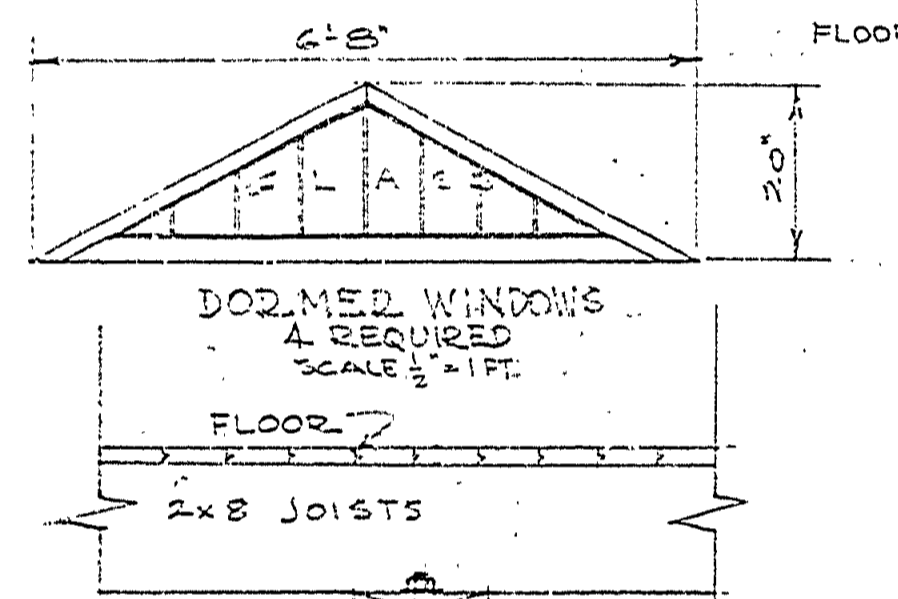

DORMER WINDOWS
4 REQUIRED
SCALE 1/2" = 1 FT.

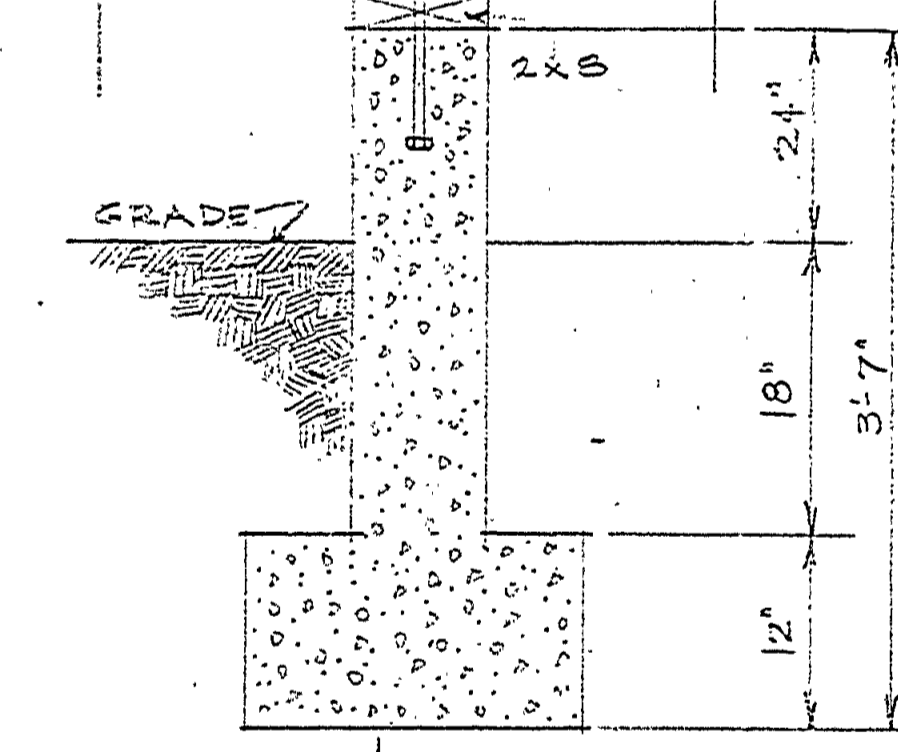

TYPICAL INSIDE FOOTING DETAIL
SCALE 1" = 1 FT.

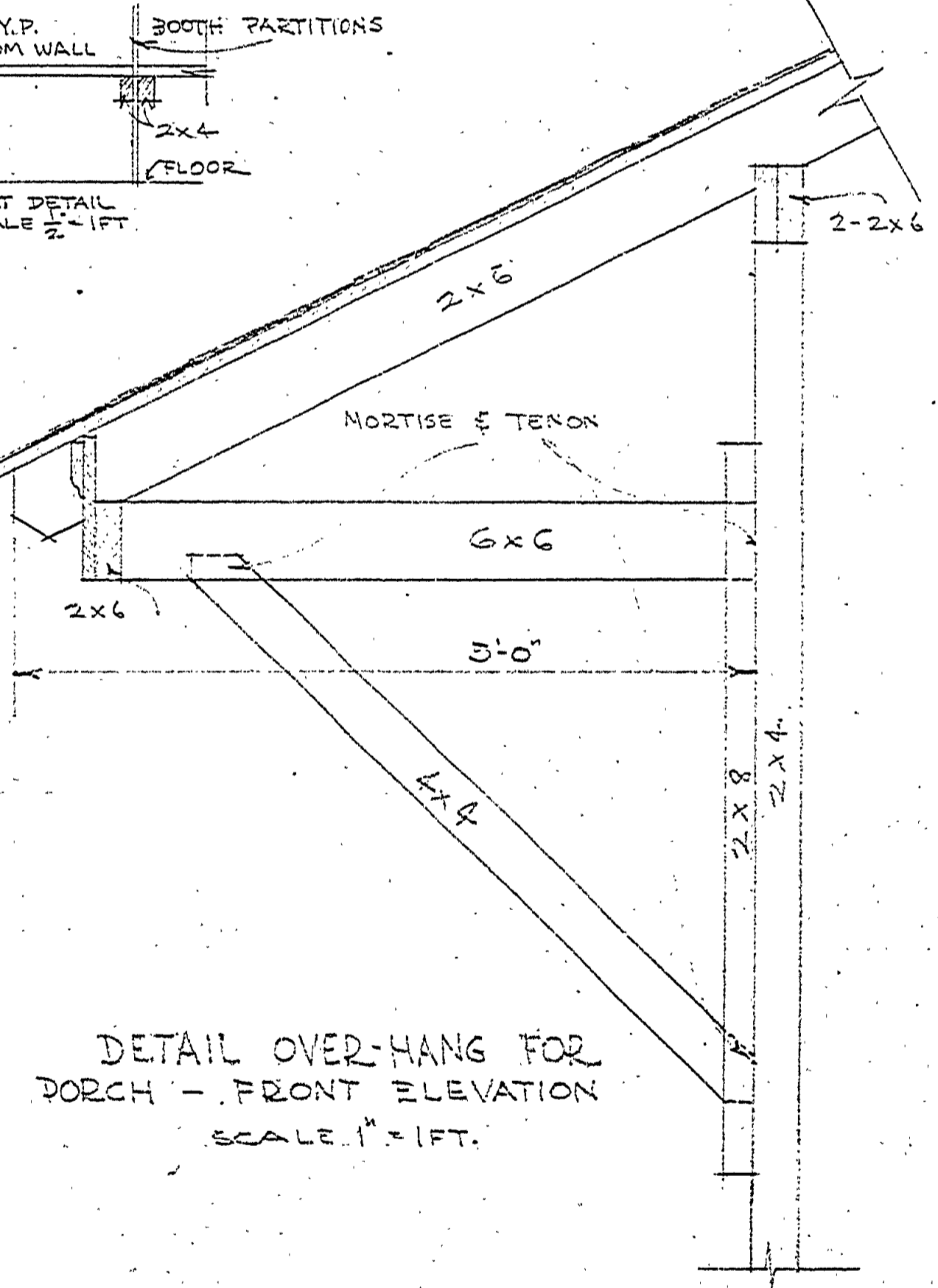

DETAIL OVERHANG FOR PORCH - FRONT ELEVATION
SCALE 1" = 1 FT.

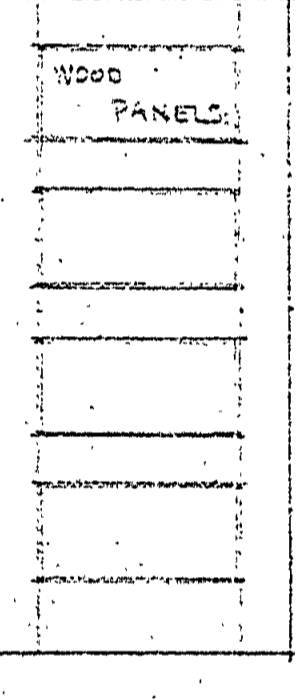

DOORS
3'-0" x 6'-0" x 1 1/2"
6 REQUIRED
SCALE 1/2" = 1 FT.

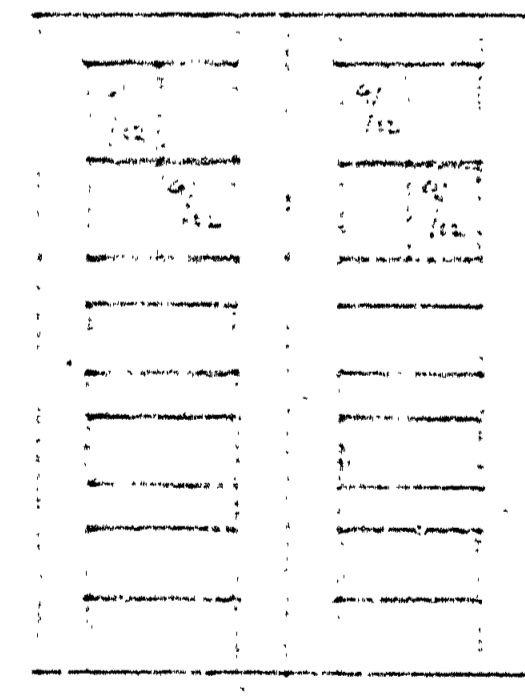

DOORS
2'-0" x 6'-0" x 1 1/2"
4 SETS REQUIRED
SCALE 1/2" = 1 FT.

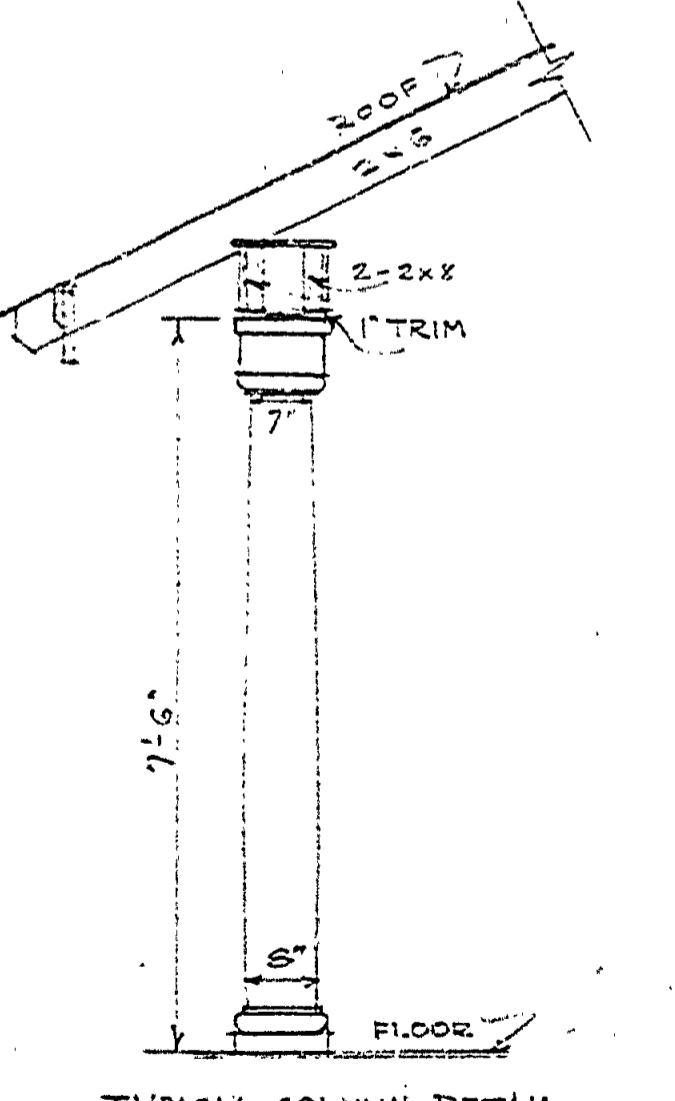

TYPICAL COLUMN DETAIL
6 REQUIRED FULL ROUND
2 REQUIRED HALF ROUND
SCALE 1/2" = 1 FT.

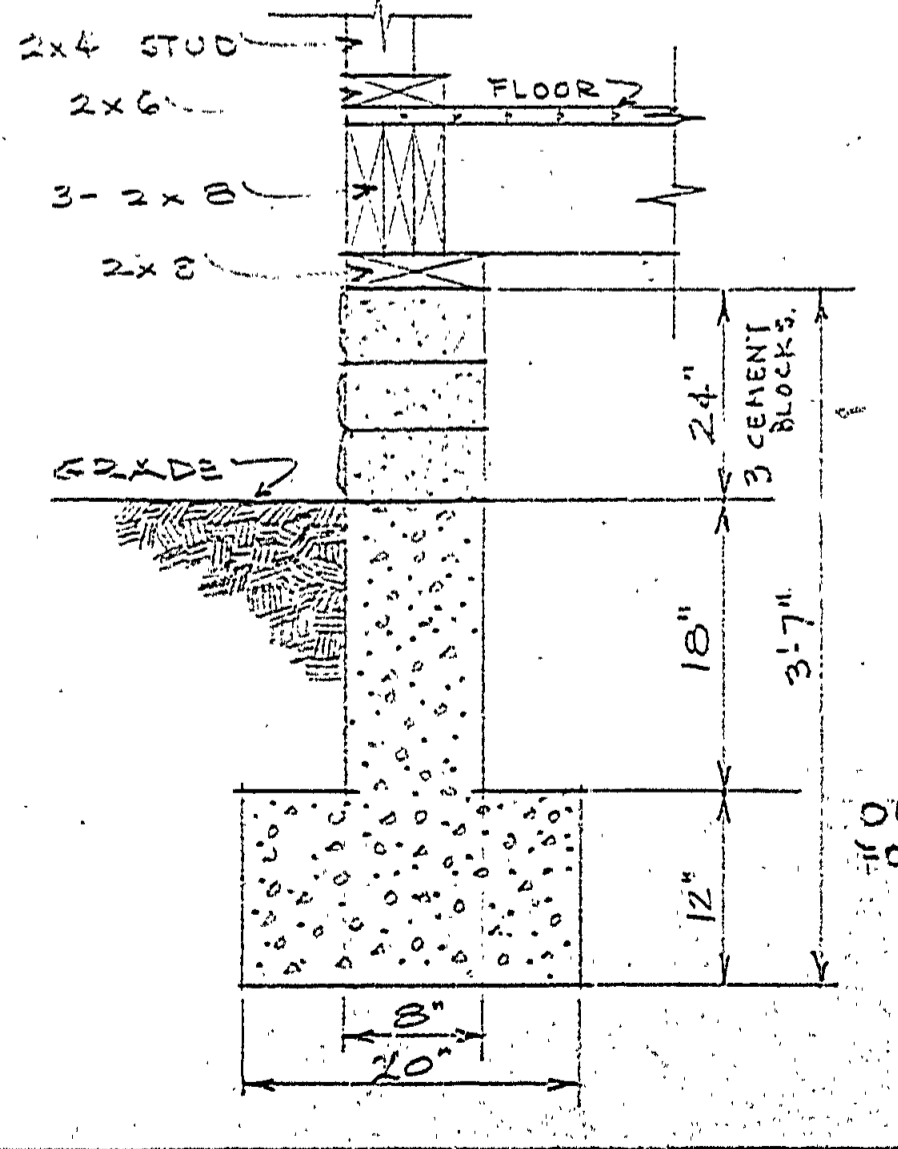

OUTSIDE WALL FOOTING DETAIL
SCALE 1" = 1 FT.

COMBINATION BATH HOUSE & PAVILION
TOILETS & CONCESSION STAND

FOR
MICH. STATE PARK
PREPARED BY
DEPT. OF CONSERVATION

JOHN BAIRD, DIRECTOR
STATE OF MICHIGAN

INSURANCE No. 4

DATE 4-14-25

A-97
Interlocken
23