

DATE	REVIEWED	DATE	APPROVED	DATE	NO.	DATE	BY	REVISIONS
2-17-41	ARCHITECTURAL	2-22-41		1	2/22/41	1	AMG	1
2-17-41	ENGINEERING	2-15-41		2	2/15/41	2	AMG	2
2-17-41	LANDSCAPE	2-12-41		3	2/12/41	3	AMG	3
				4		4		4
				5		5		5
				6		6		6

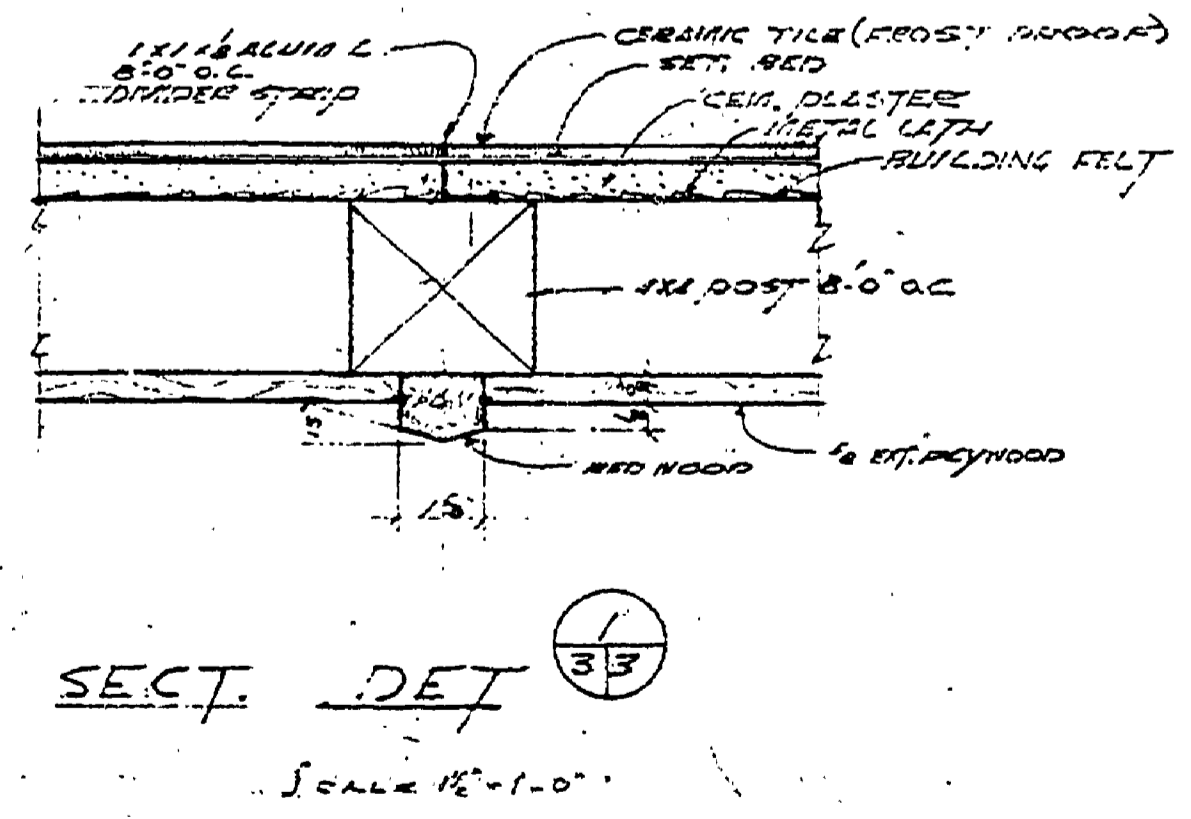
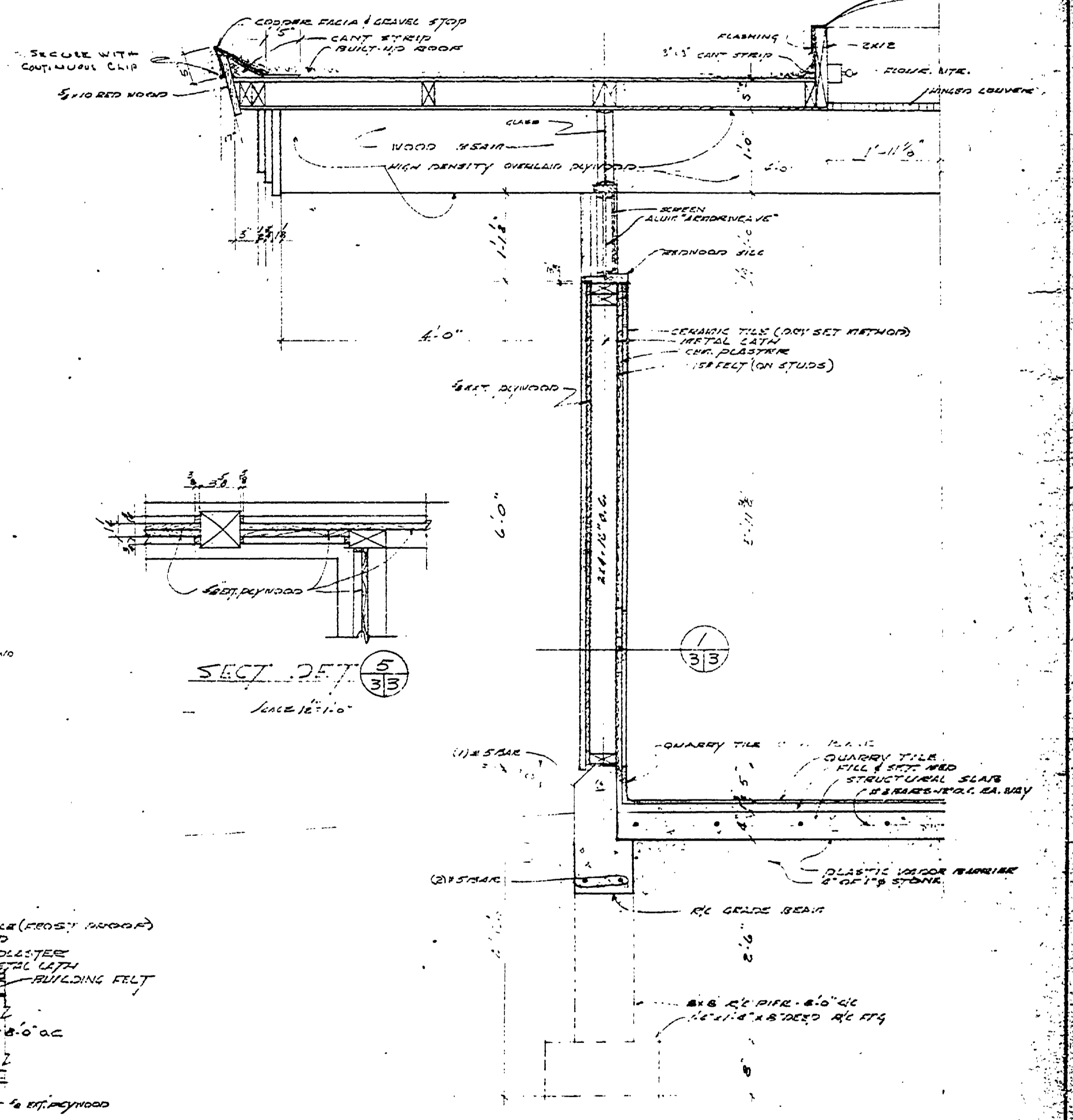
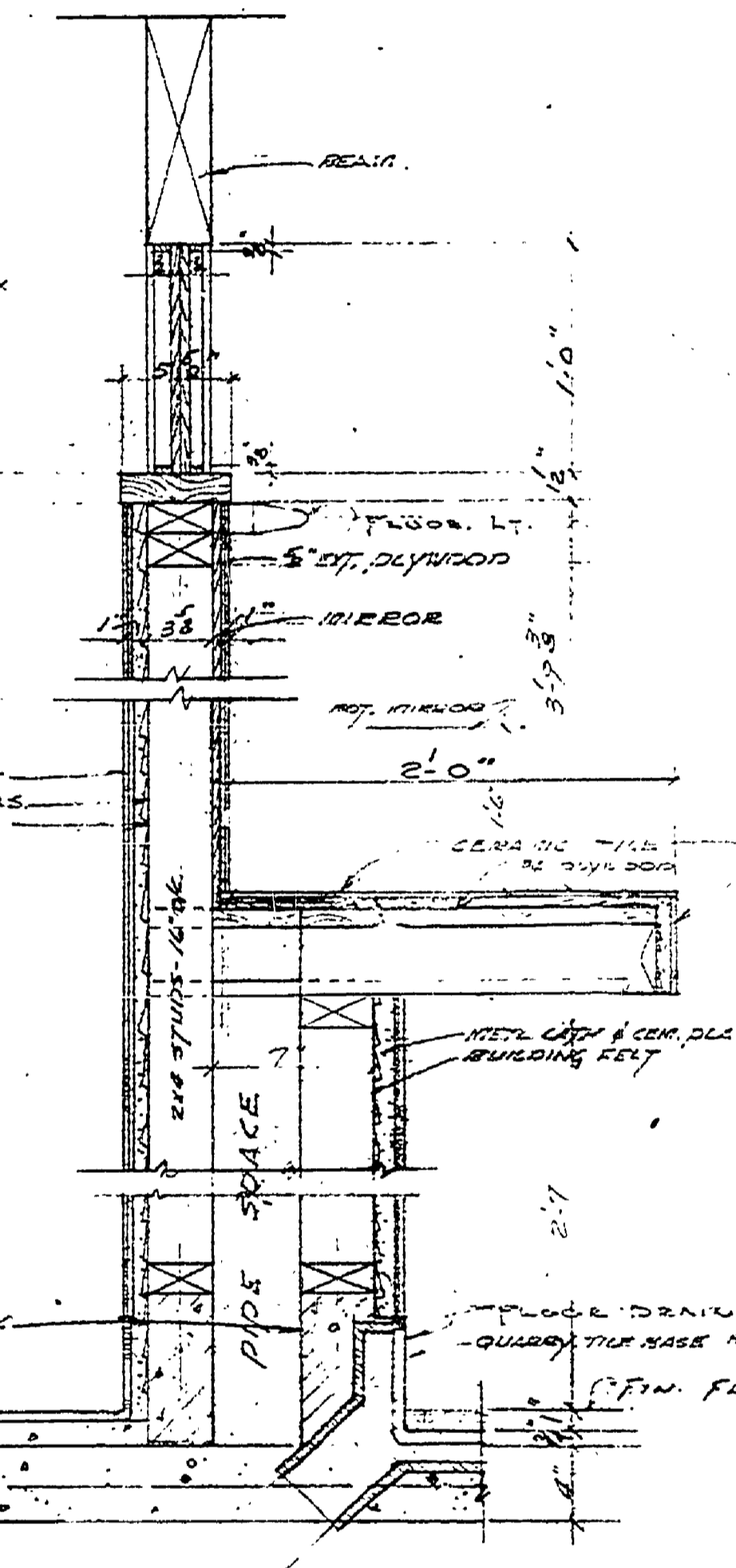
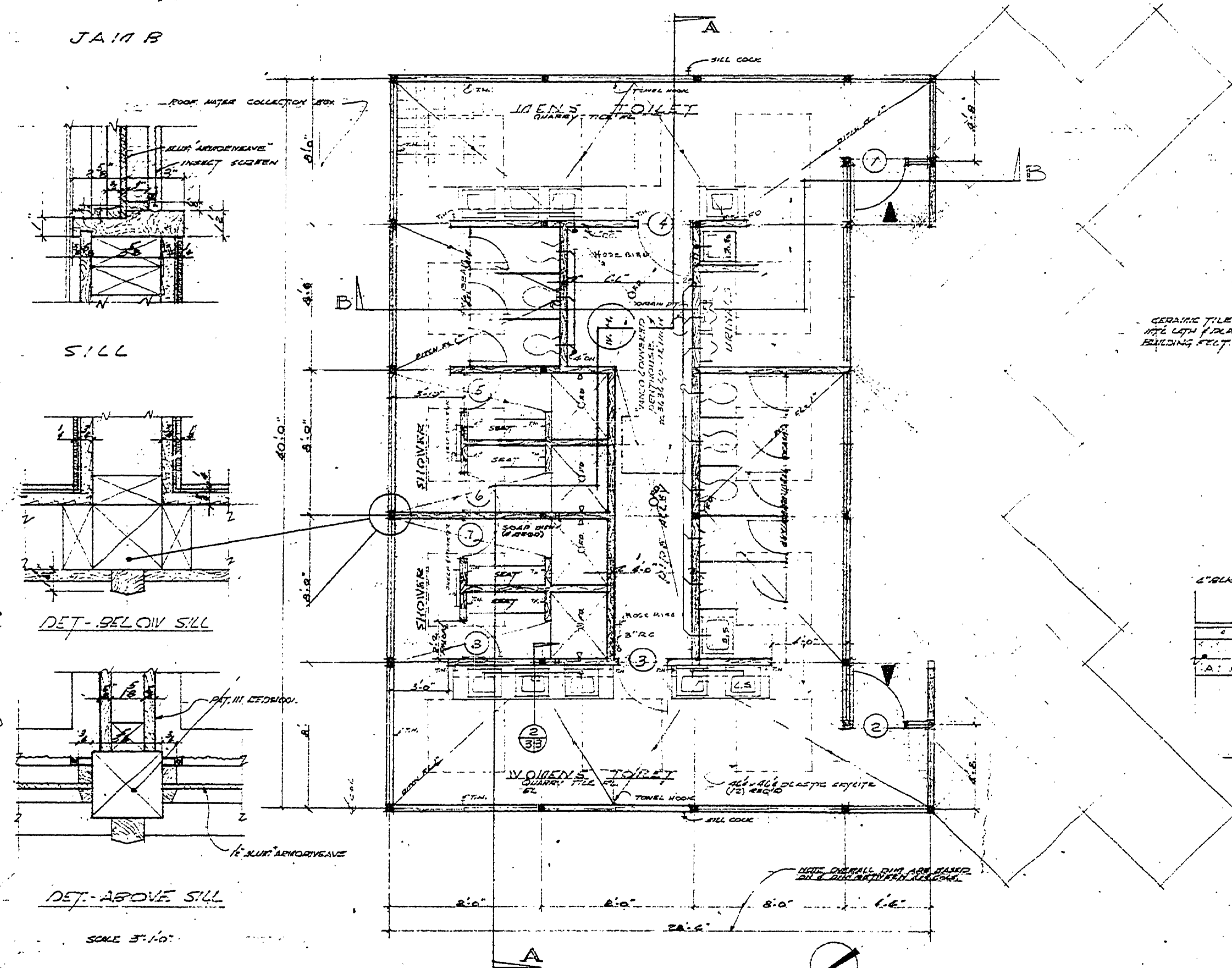
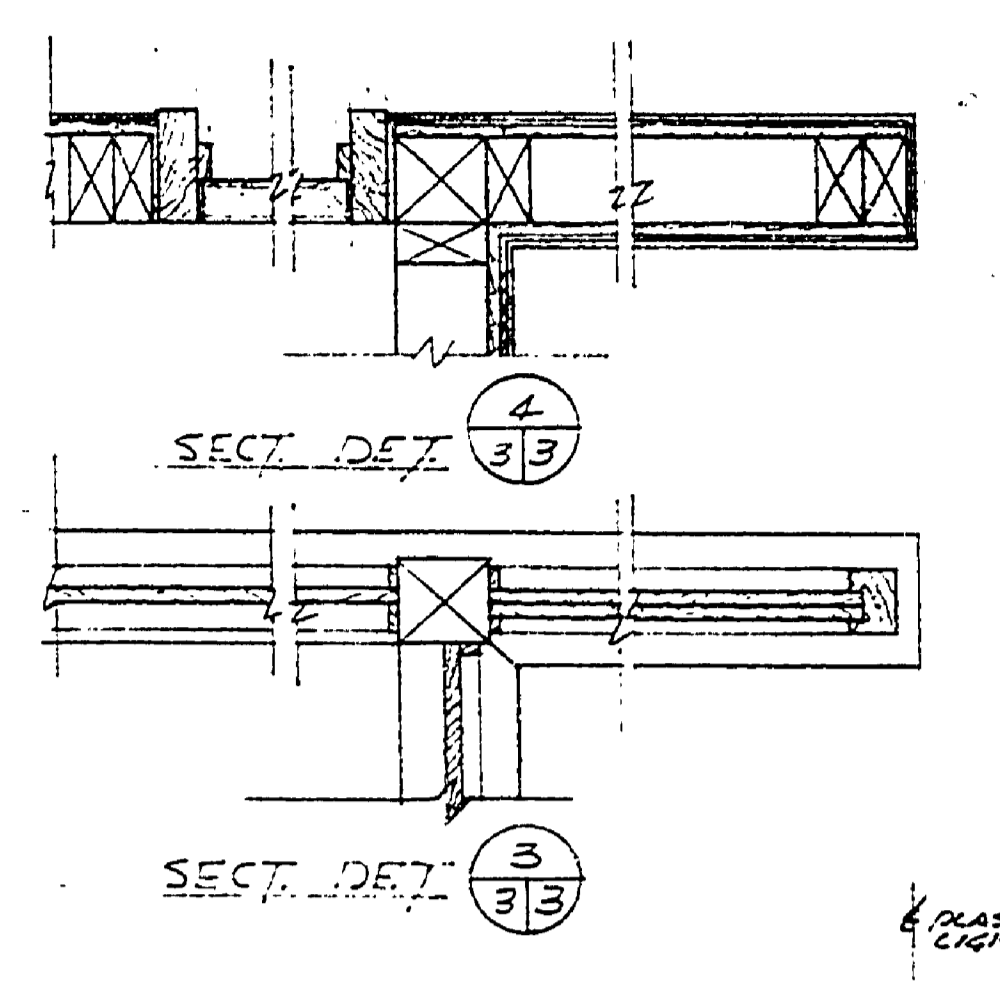
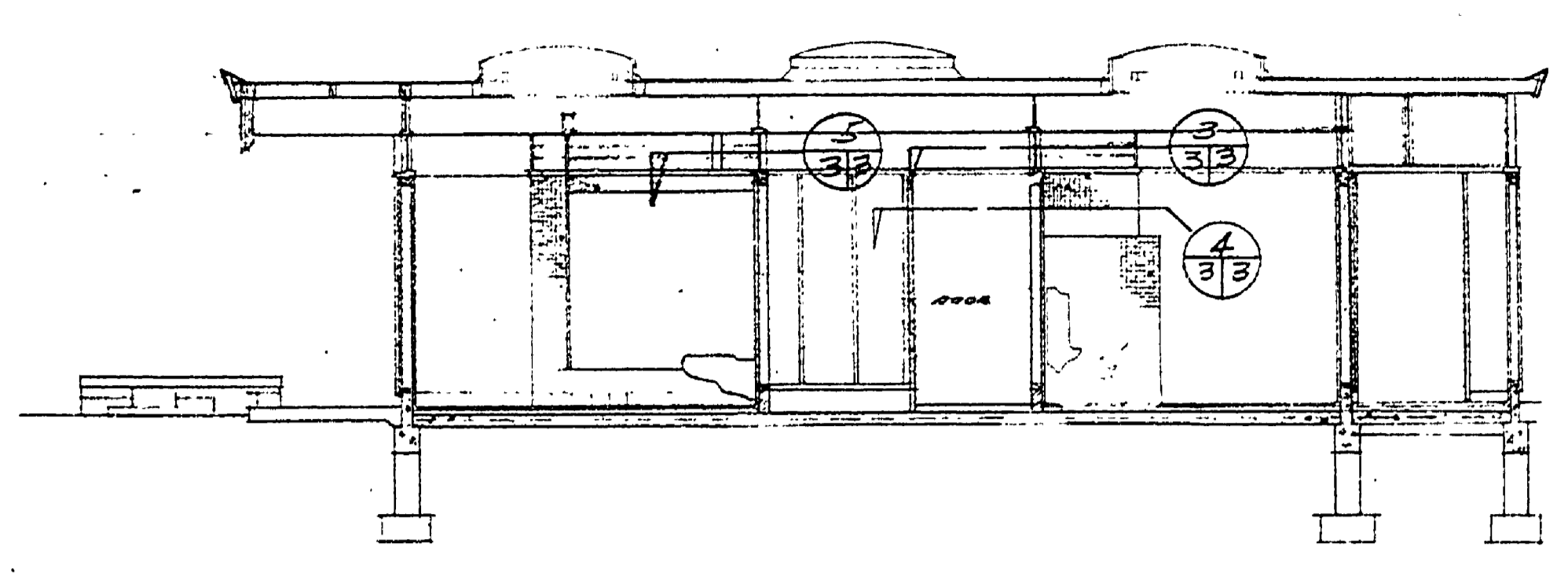
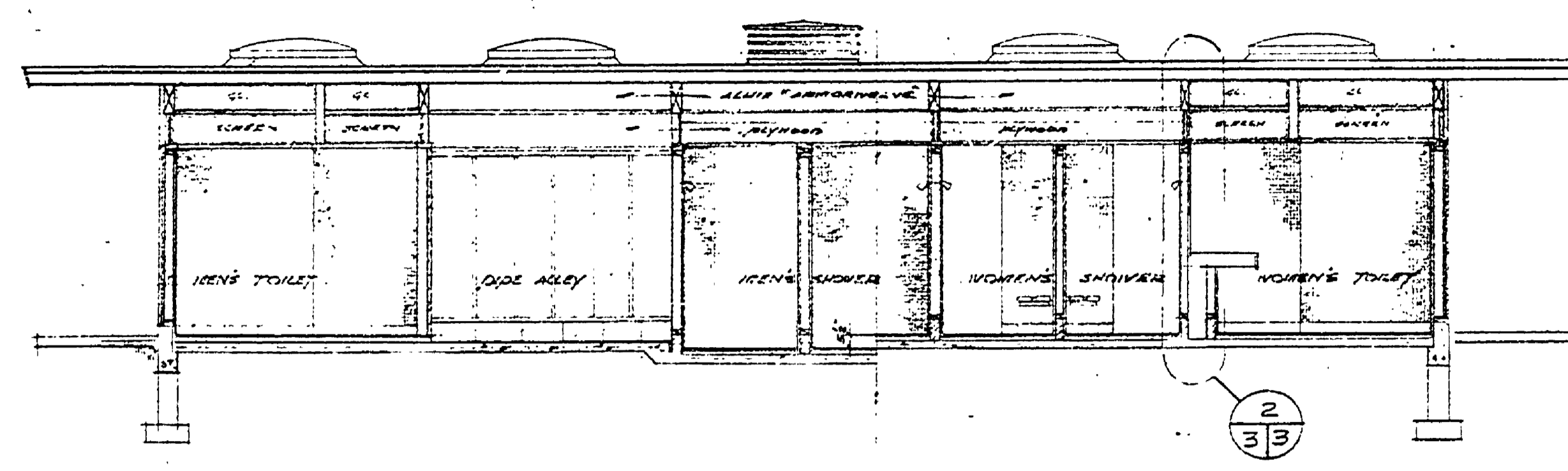
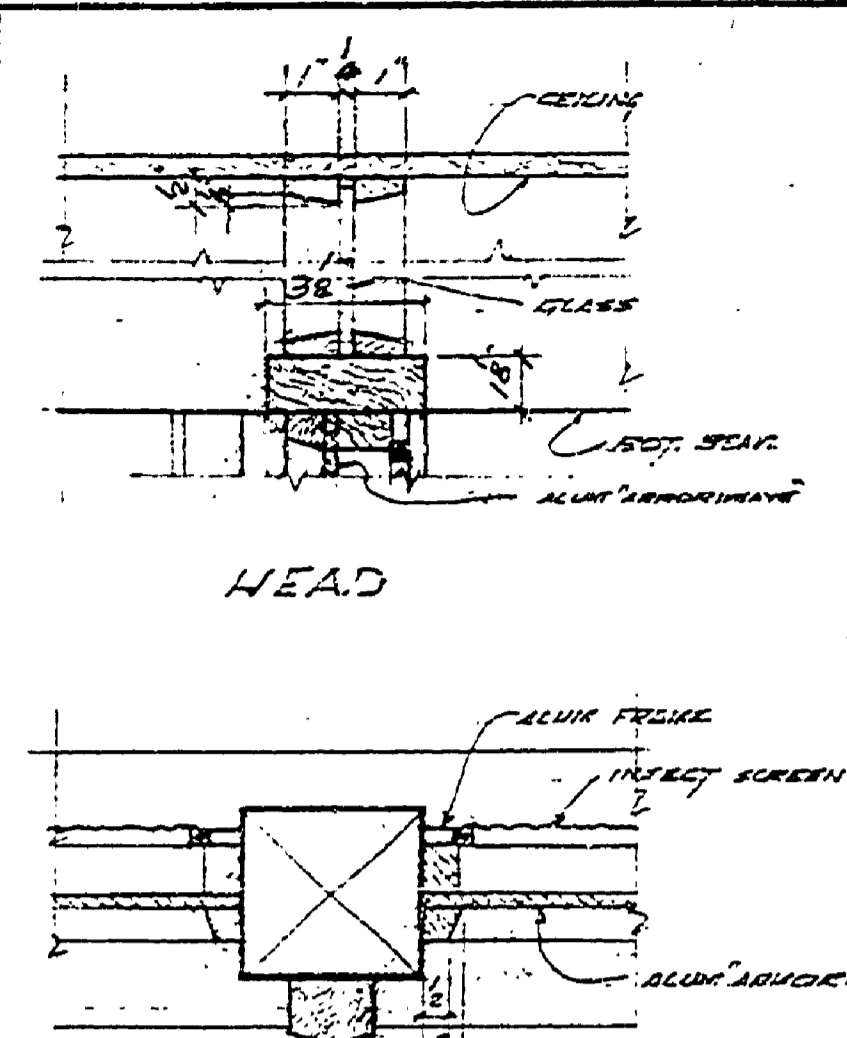

FLOOR PLAN - SECTIONS - DETAILS		PLAN NO.
ALPHA STATE PARK		NO. 2
TOILET & SHOWER BUILDING		OF 5

MICHIGAN
DEPARTMENT OF CONSERVATION
PARKS AND RECREATION DIVISION