

DESIGNED BY	ELB. K.E.D.
TRACED BY	F.J.P.
CHECKED BY	F.J.P.
DATE	9 Sept. 1946
REVIEWED BY SECTIONS	ARCHITECTURAL ENGINEERING LANDSCAPE
DATE	
APPROVED BY	ASSISTANT CHIEF IN CHARGE OF DESIGN
DATE	
NO.	1
DATE	2
NO.	2
DATE	3
NO.	3
DATE	4
NO.	4
DATE	5
NO.	5
DATE	6
NO.	6

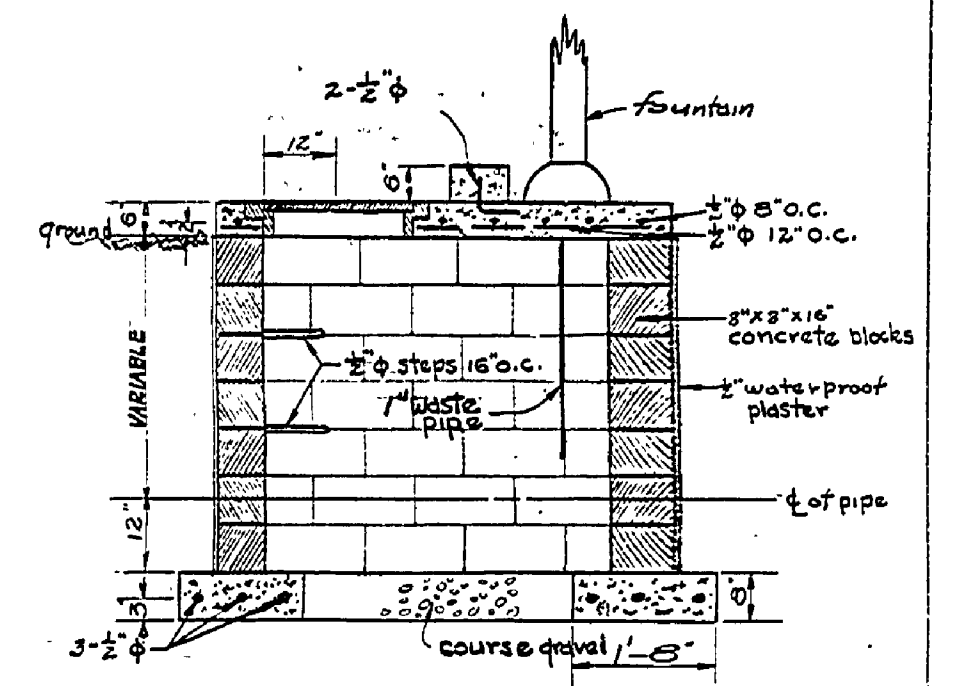

SECTION AA  
MANHOLE  
Scale 3/4"=1'  
Note: If manholes are below ground water provide concrete bottom and water-proof  
Note: Build all manholes without fountains 4'-0" square

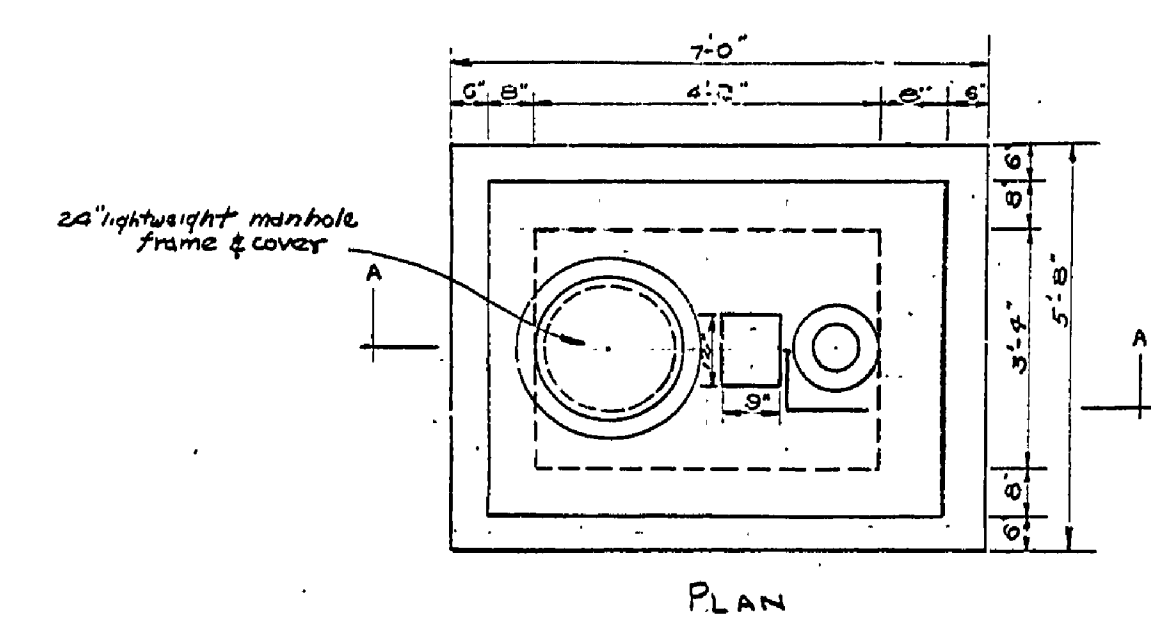
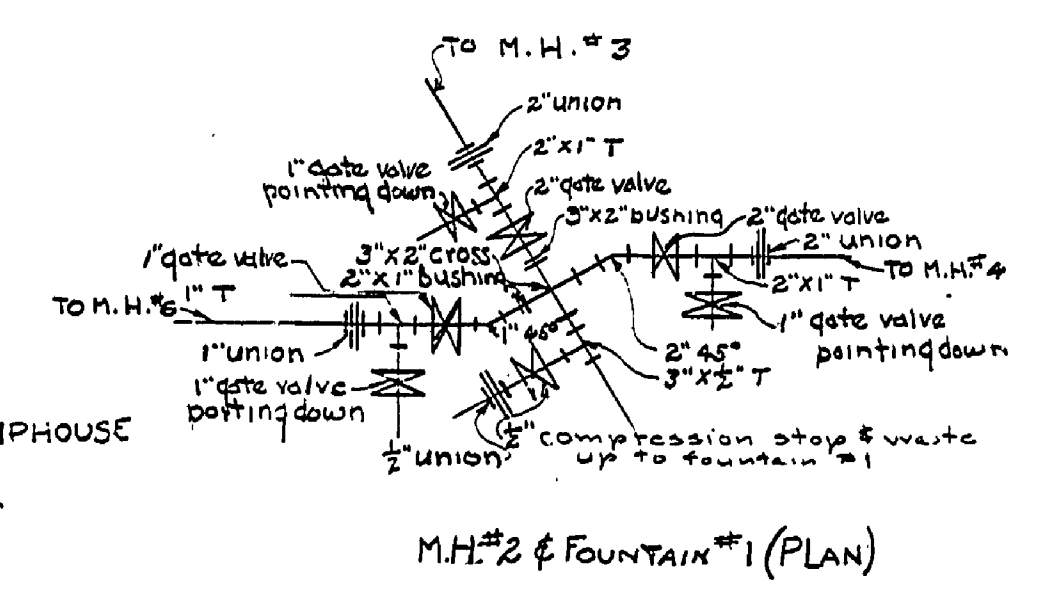
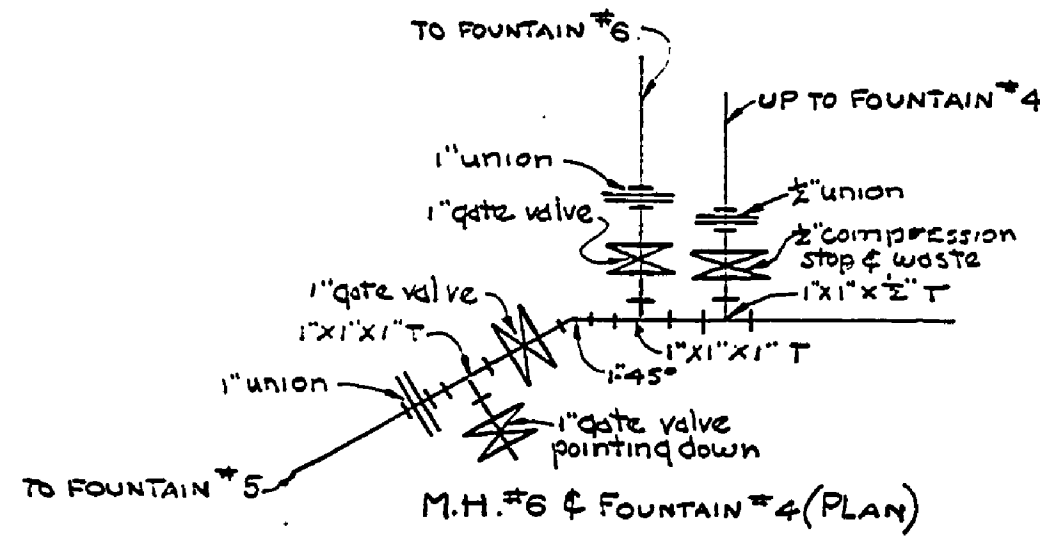
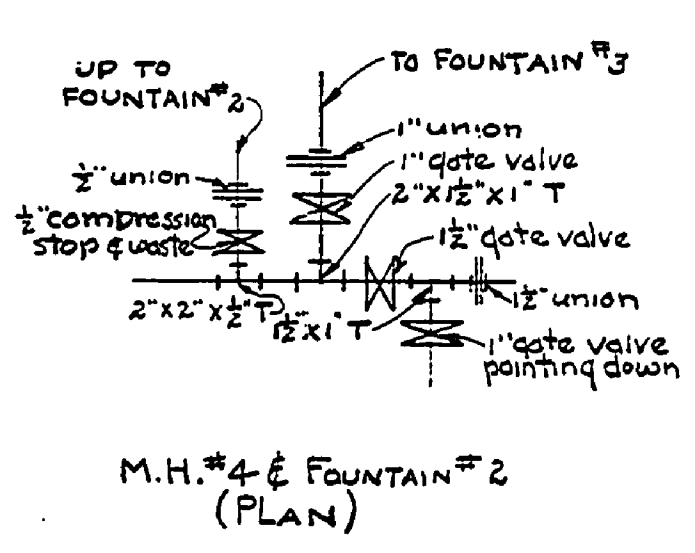
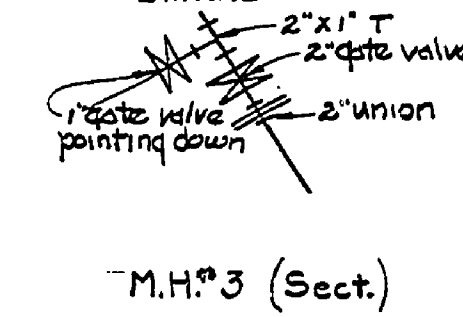
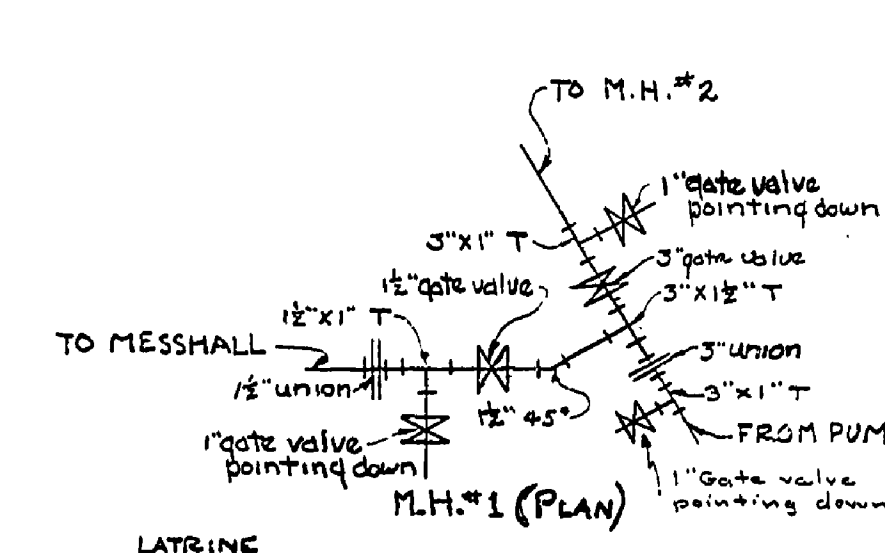
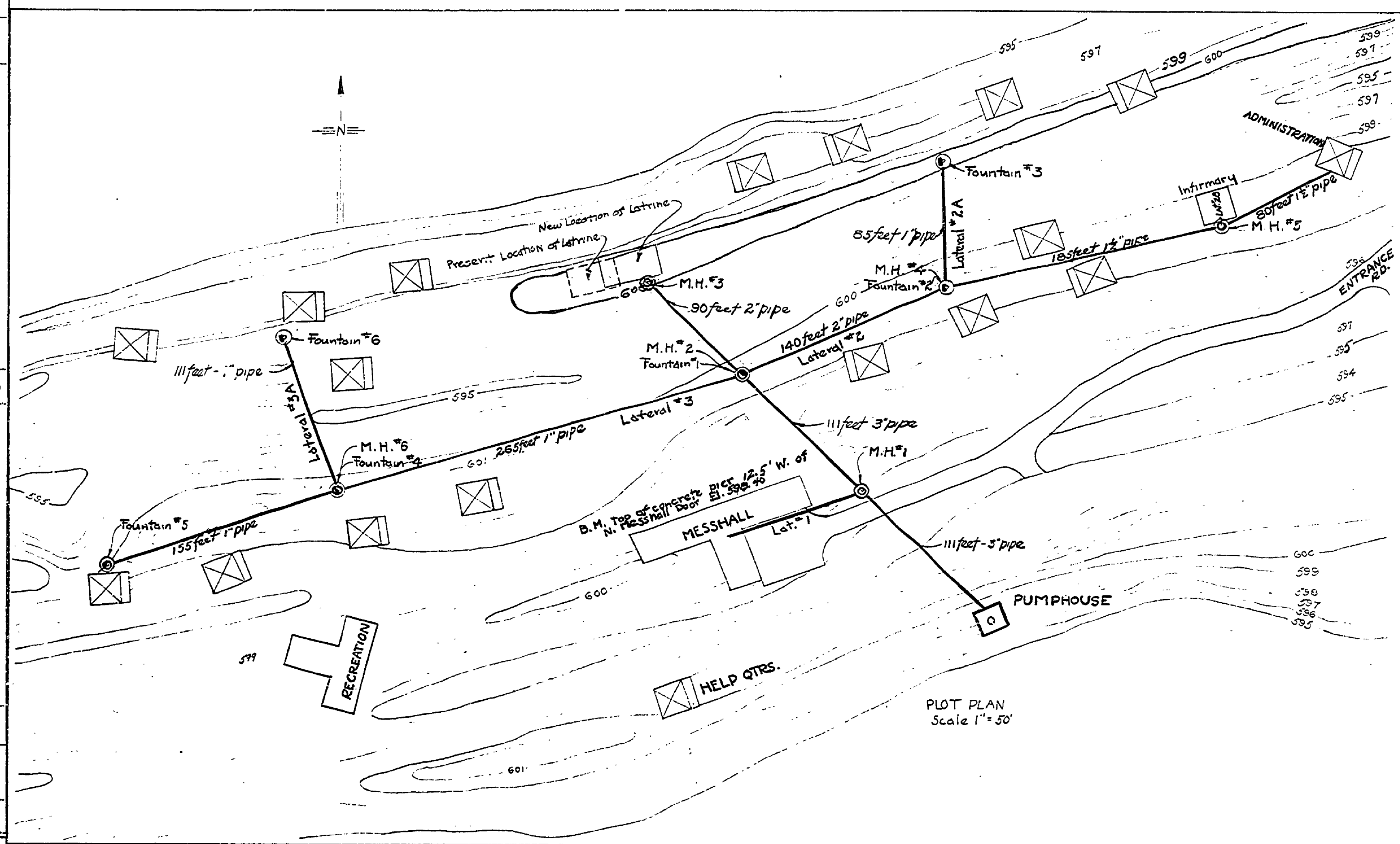
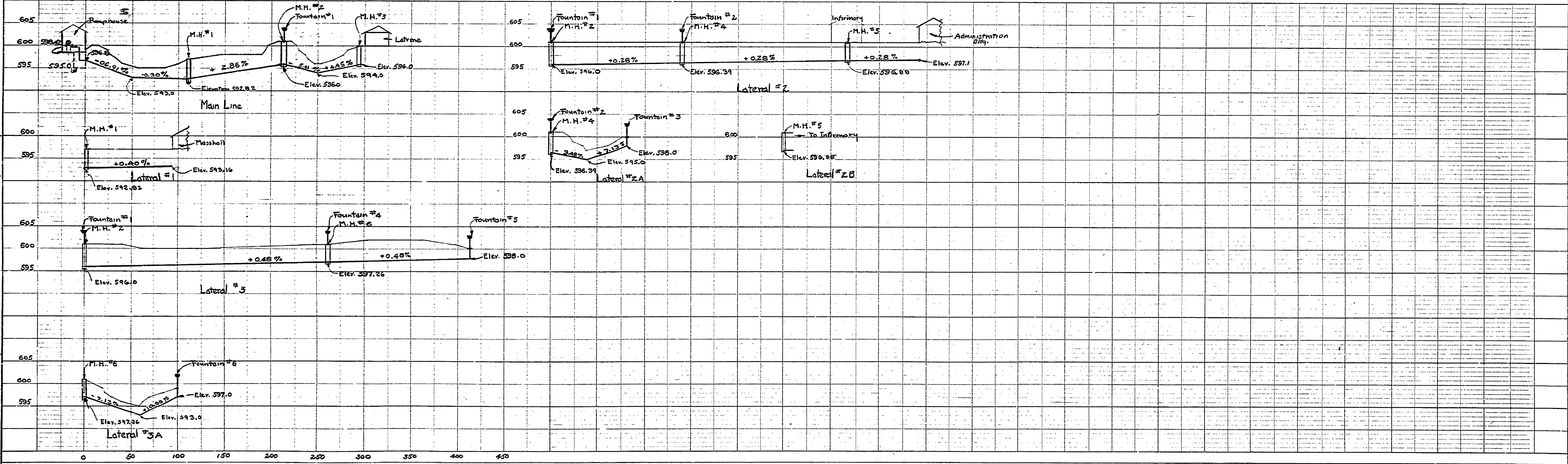

MICHIGAN  
DEPARTMENT OF CONSERVATION  
PARKS AND RECREATION DIVISION

SLEEPER STATE PARK  
WATER DISTRIBUTION SYSTEM  
SCALE 1"=50'  
GROUP CAMP

SHEET NO. 1 OF 1  
PLAN NO. E-103