

DATE	BY	REVISIONS
9-18-57	J.R.	1
9-17-57	H.C.M.	2
9-18-57	J.T.B.	3
9-18-57	J.T.B.	4
9-18-57	J.T.B.	5
9-18-57	J.T.B.	6

NO.	CATALOGUE NO.	WIDTH	HEIGHT	NO. LIGHTS	MULLIONS	VENT. CO.	FIXED	SCENES	REMARKS
A-1	2000	4'-0"	7'-0"	2	1				
B-2	4000	4'-0"	7'-0"	2	1				
C-2	4000	4'-0"	7'-0"	2	1				

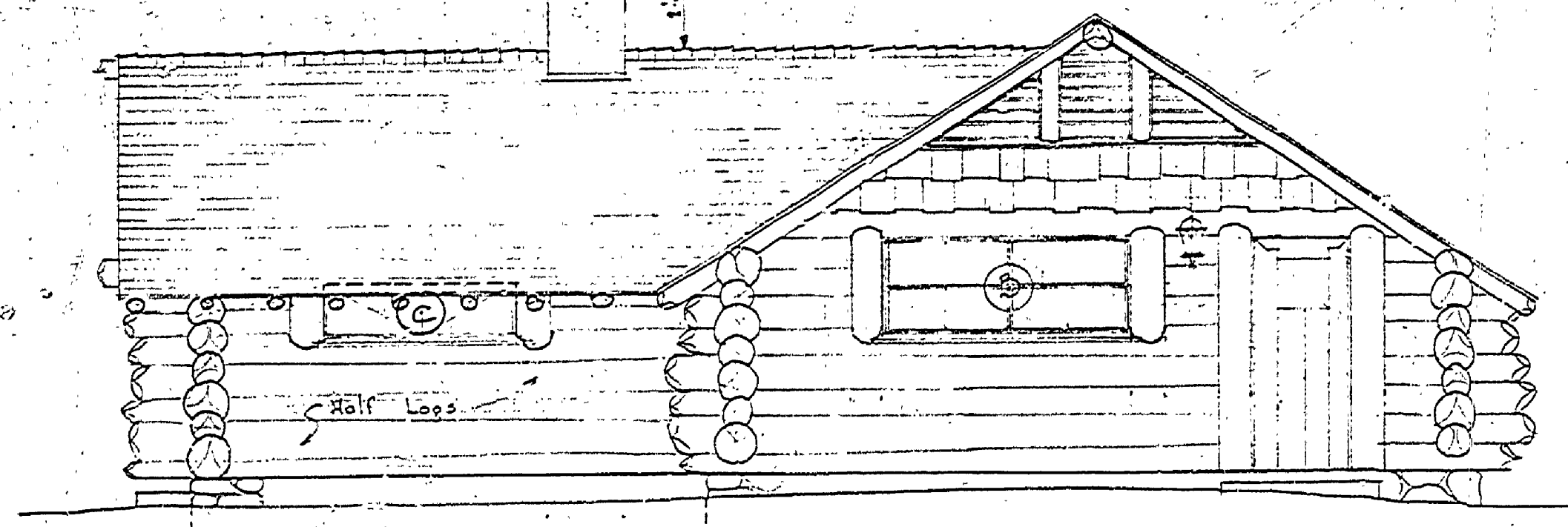

NORTH WEST ELEVATION

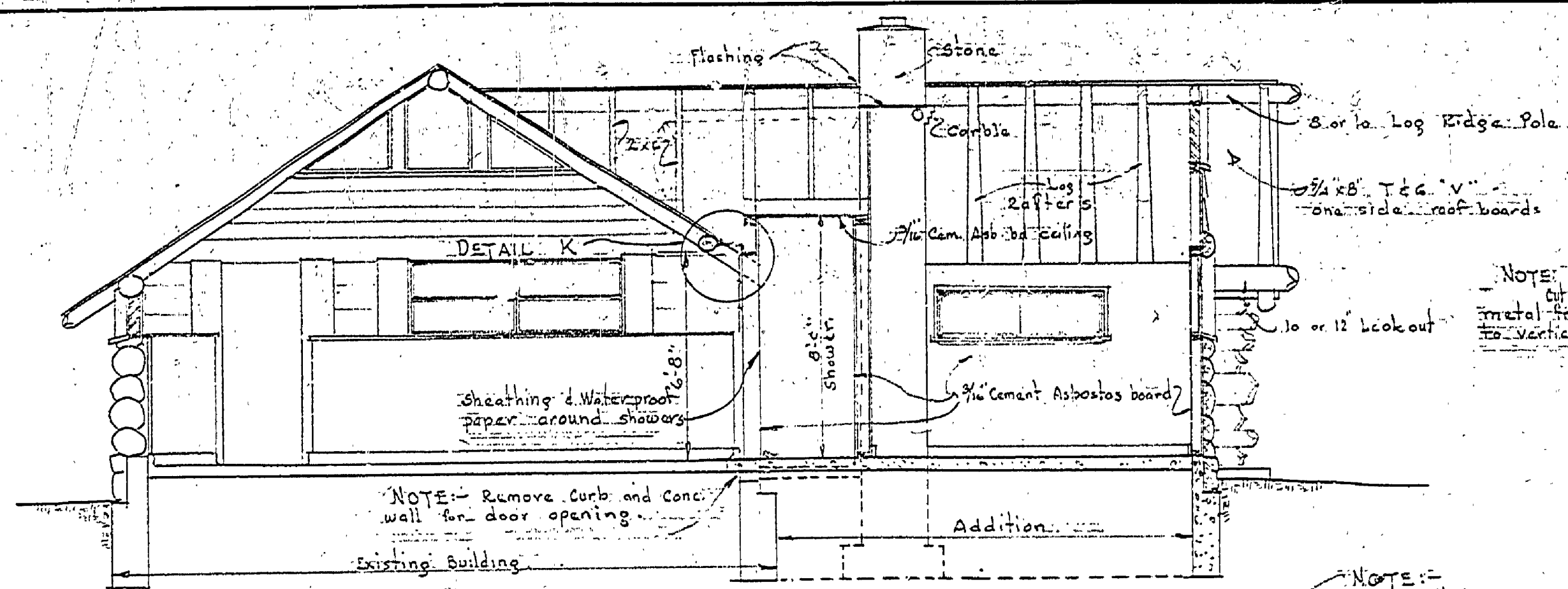

SECTION A-A

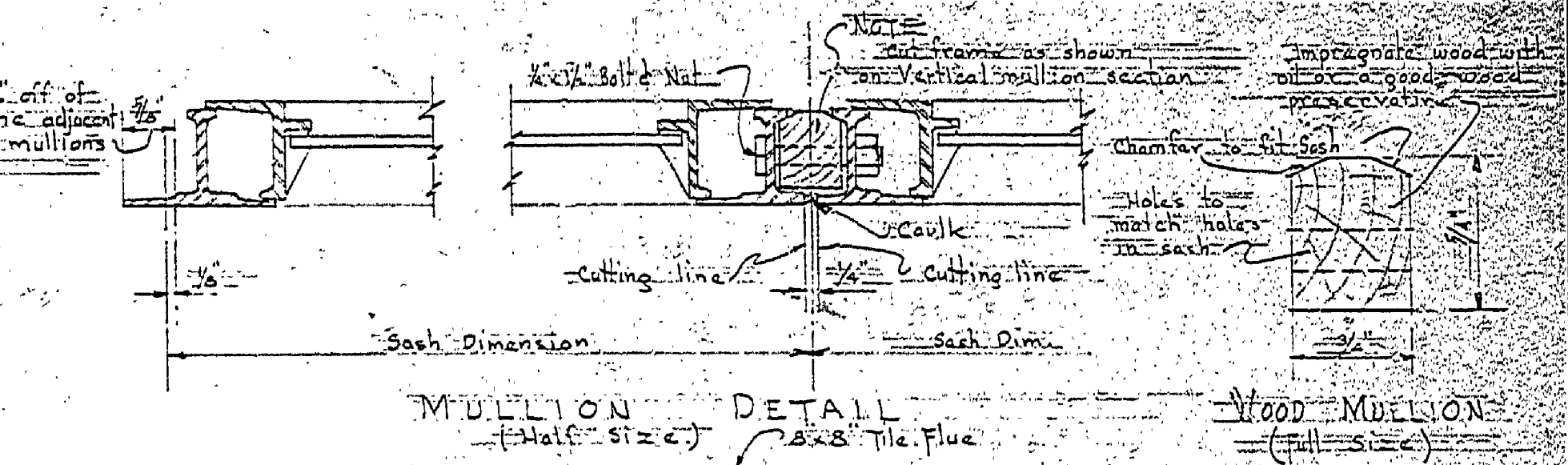

MULLION DETAIL

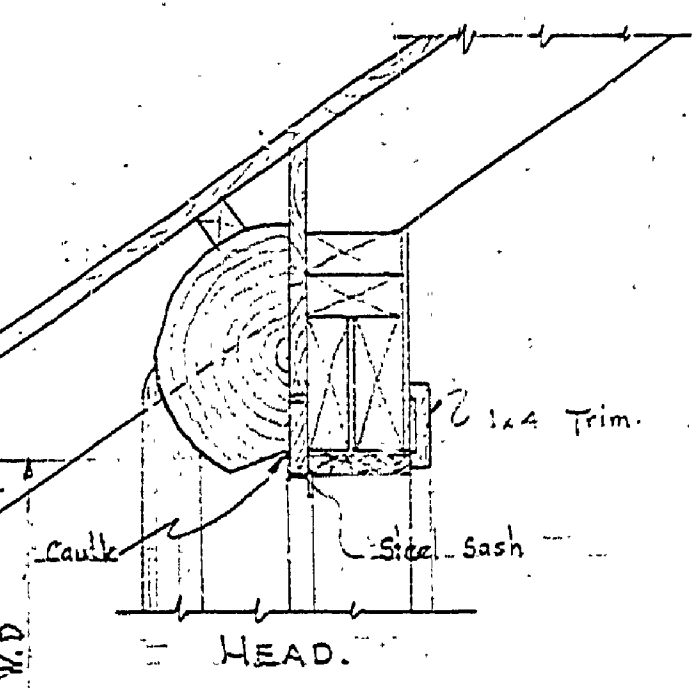

HEAD

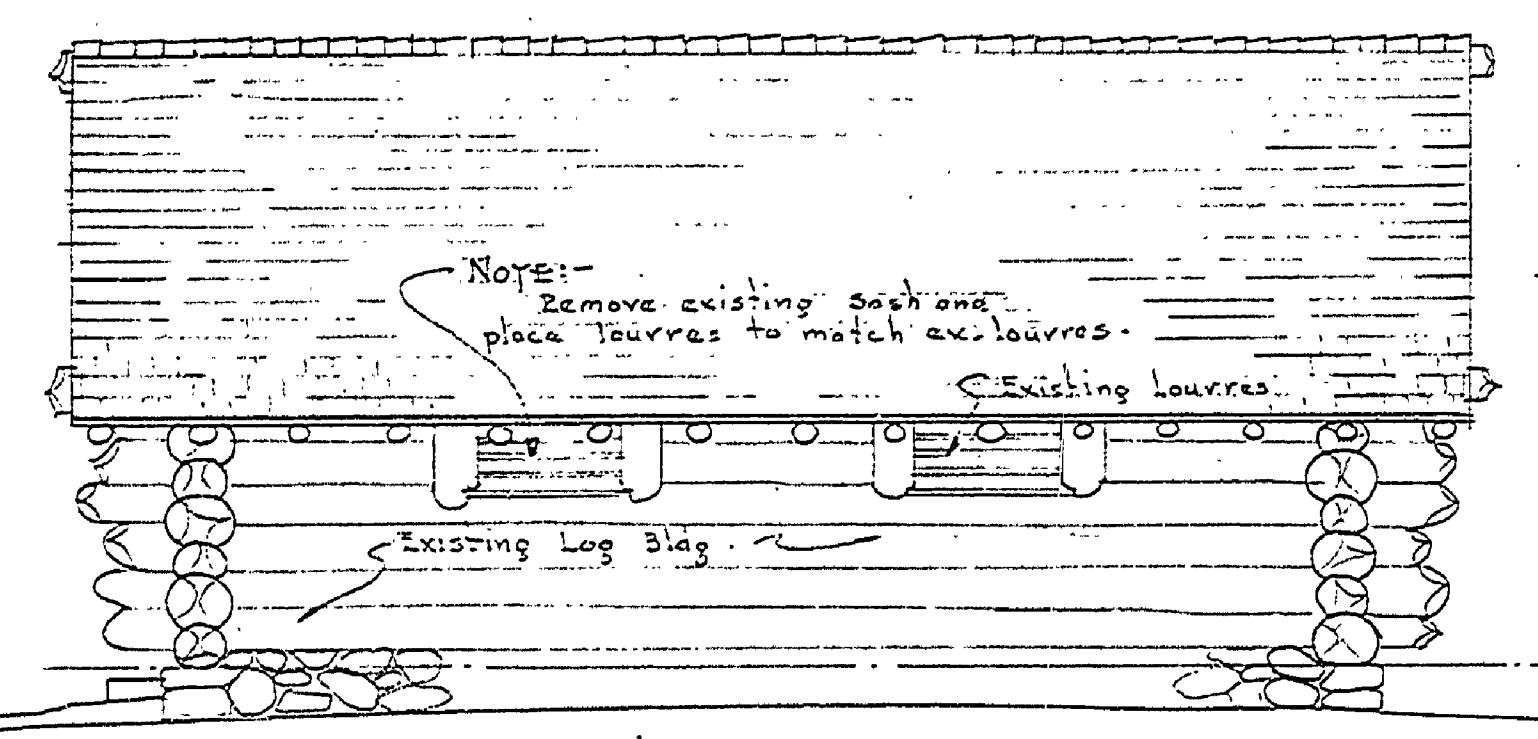

SOUTH WEST ELEVATION

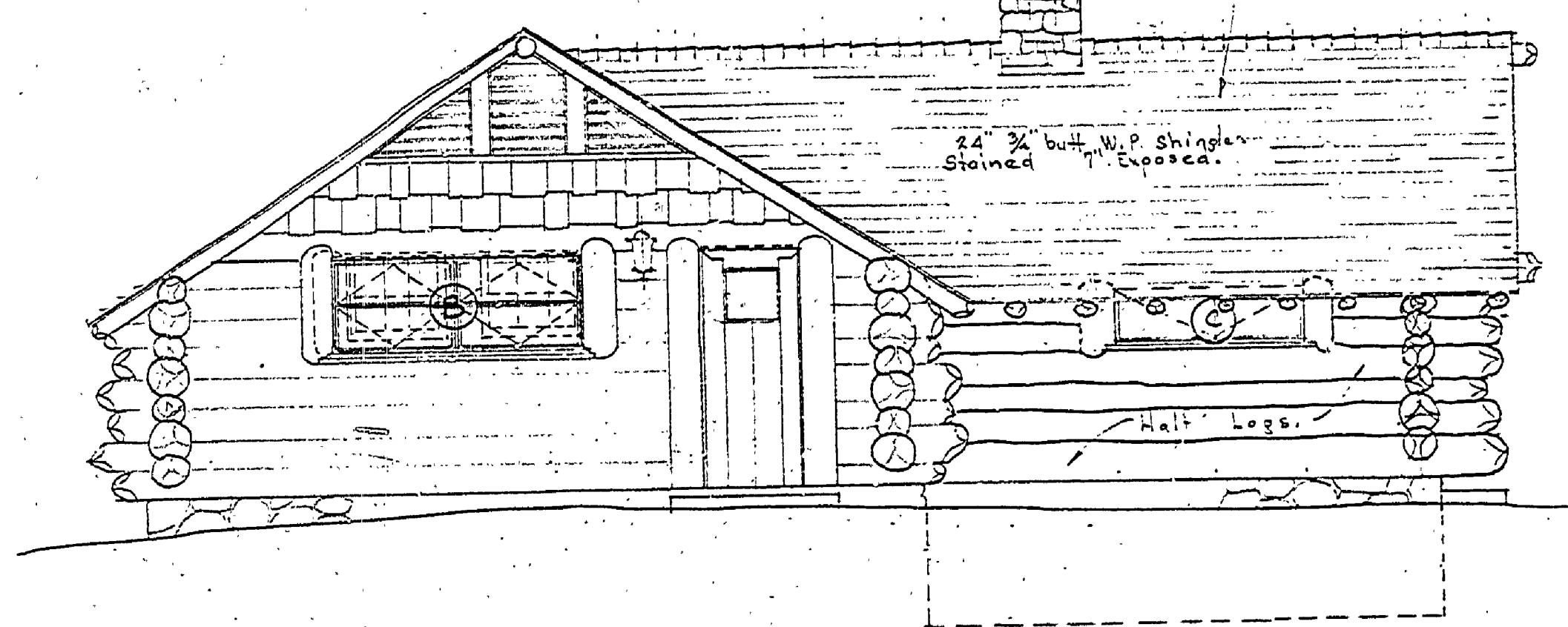

SOUTH EAST ELEVATION

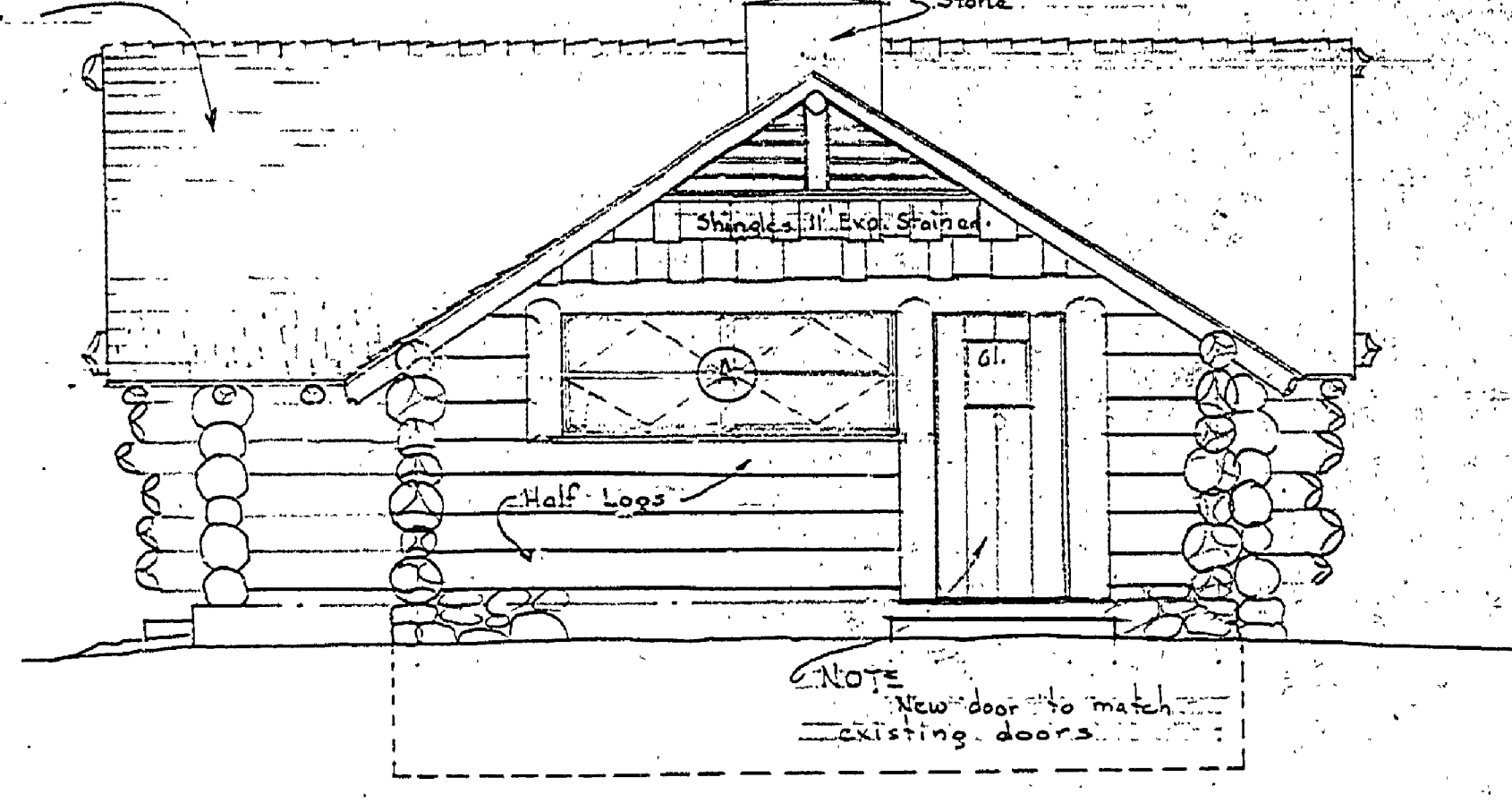

NORTH EAST ELEVATION

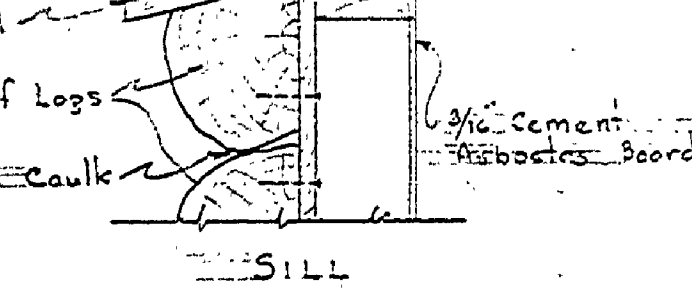

SILL

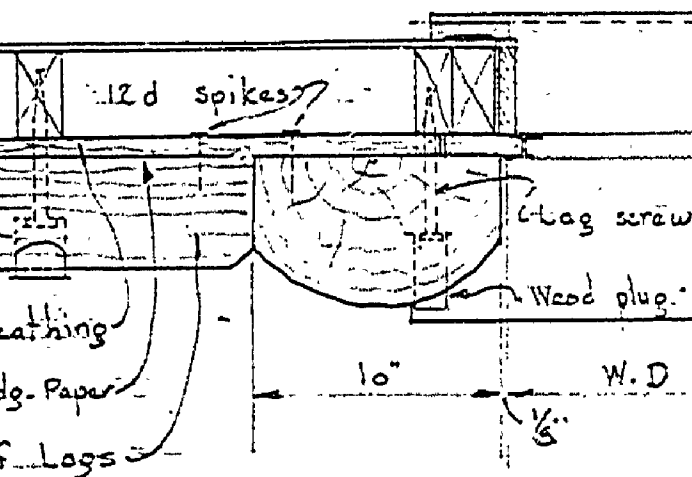

JAMB

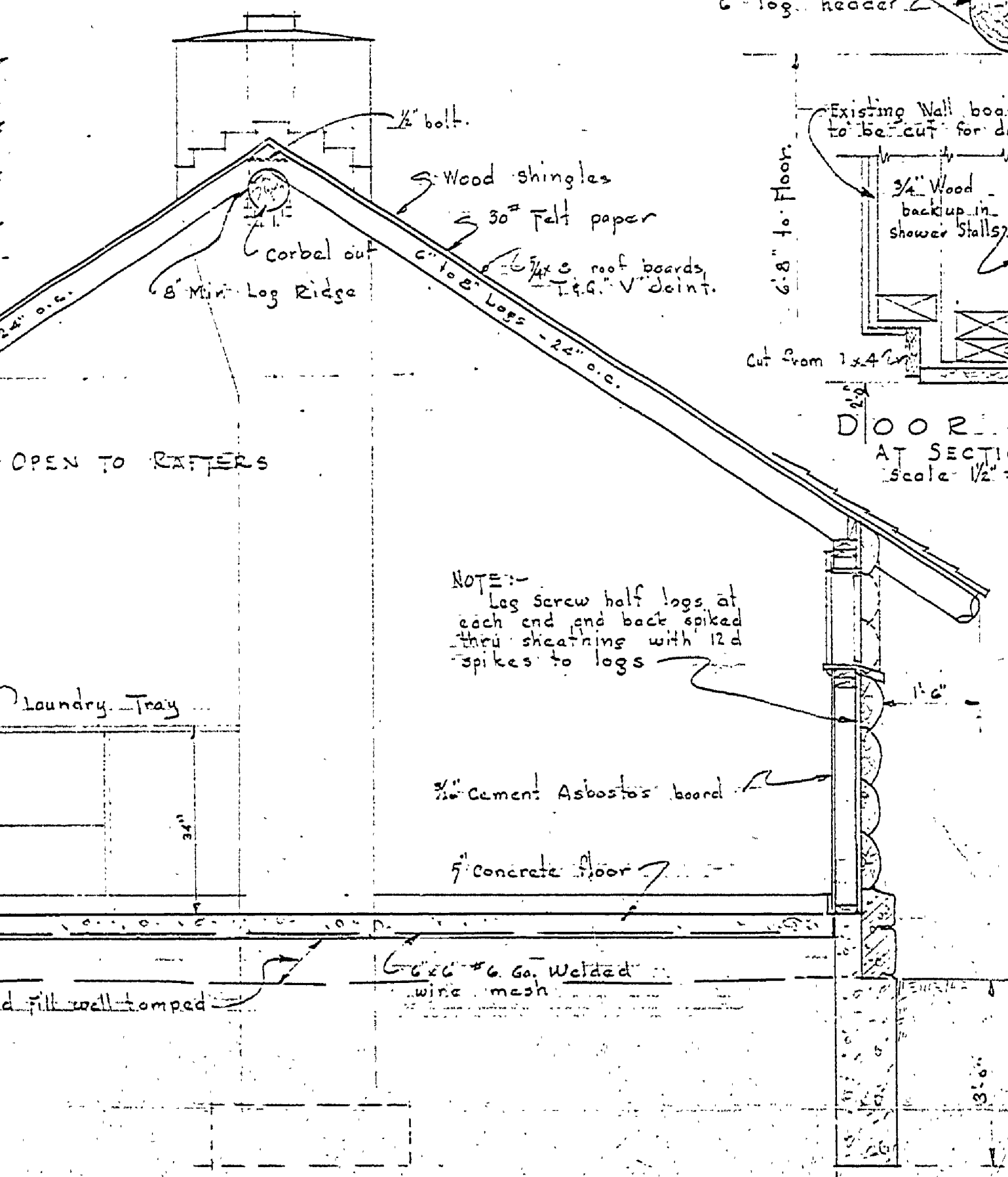

SECTION THRU LAUNDRY

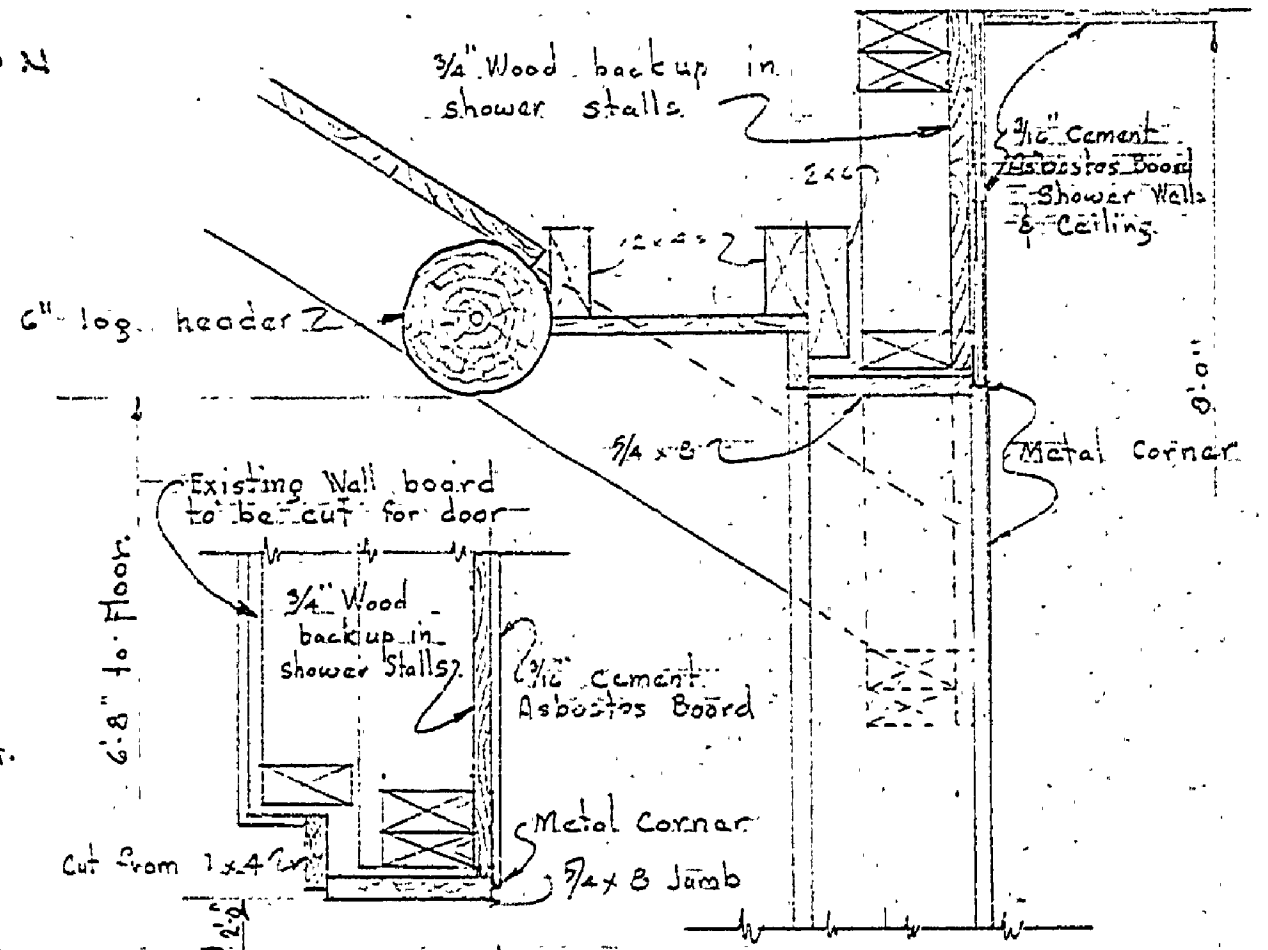

DOOR JAMB & DOOR HEAD

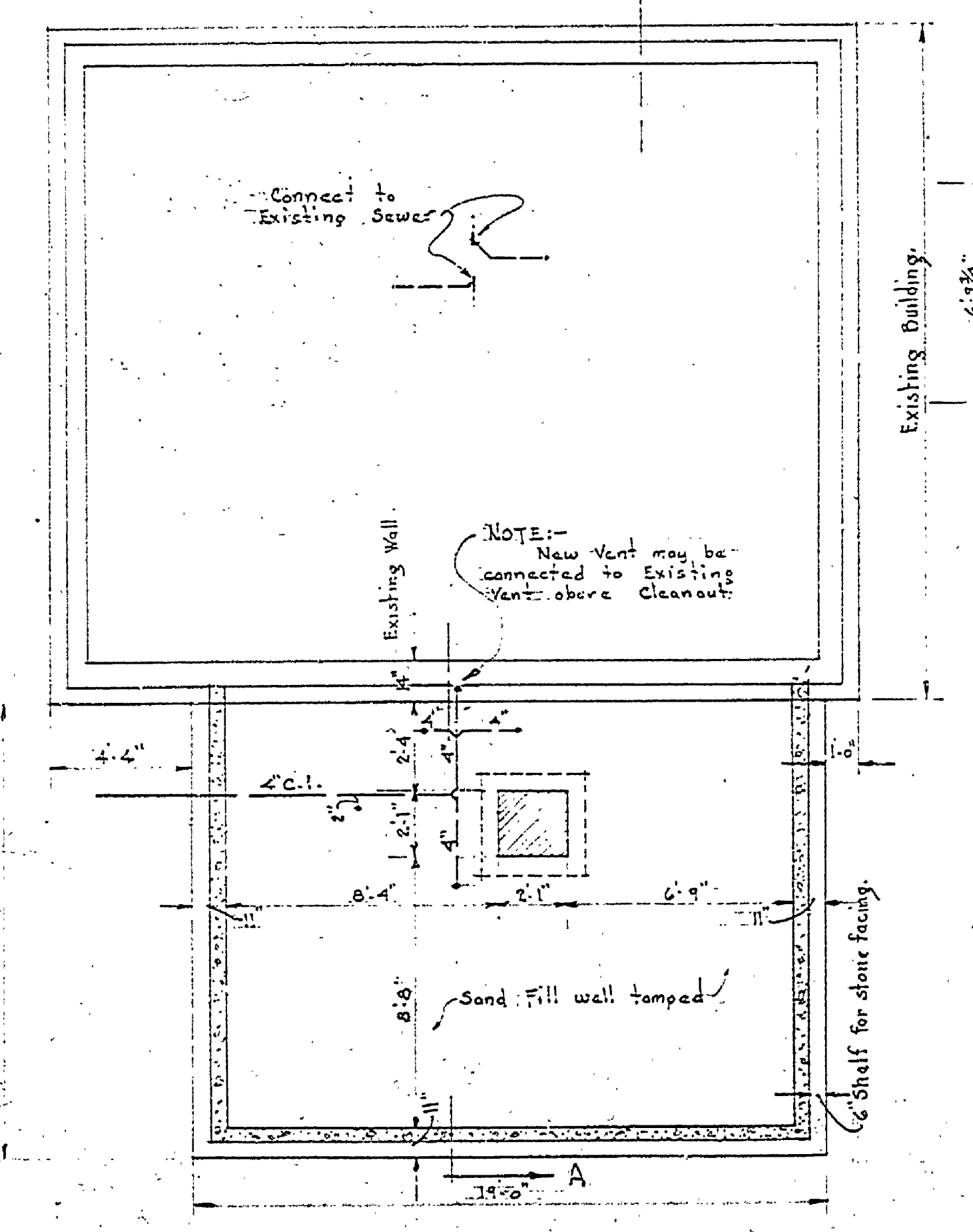

FOUNDATION & SEWER PLAN

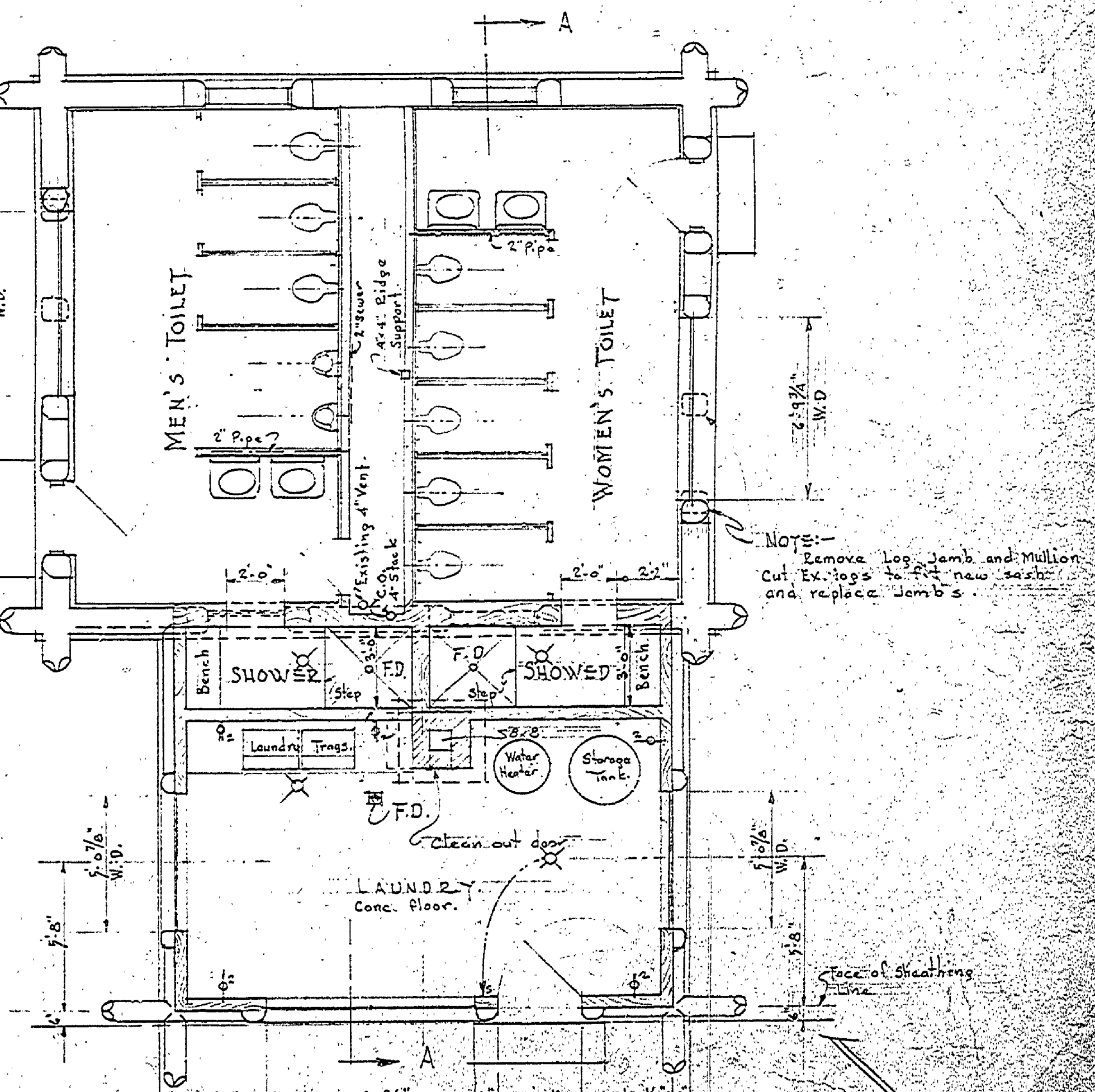

FLOOR PLAN

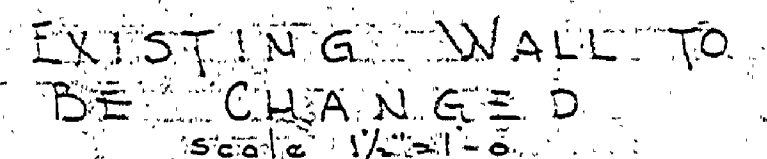

EXISTING WALL TO BE CHANGED

NOTE: For original drawing & detail see standard plan # S-A-113